



**GIOVENZANA
INTERNATIONAL B.V**

AUTOMATION TECHNOLOGIES



AUTOMATION

GENERAL CATALOGUE



GIOVENZANA
INTERNATIONAL B.V.
AUTOMATION TECHNOLOGIES

AUTOMATION CATALOGUE

GIOVENZANA INTERNATIONAL reserves the right to modify, in order to improve their performance, all technical and functional characteristics of the products shown in the catalogue without prior notice as this information is intended for general knowledge and is not legally binding.

THE PHILOSOPHY

Giovenzana's philosophy is based upon the basic principles of business management, dynamism and the continuous research for the operator's needs in the field of man-machine interaction. These principles, thanks to the experience and professionalism of its staff, guarantees Giovenzana's development and growth.

THE HISTORY

With over 60 years experience in this field and excellent managerial skills, Giovenzana has maintained growth relying upon:

- market research
- product placement
- manufacturing technology, and above all, team work

THE PRODUCTS

Giovenzana, leader in the industrial technology field, is the first choice for:

- handling equipment
- automation
- lifting equipment
- maintenance
- command and control of moving parts

Development, design and production are combined to reach a common goal and cover most industrial applications.

QUALITY AS A WAY OF LIFE

The commercial success of a product does not happen by chance, but is the end result of the combined efforts of all human resources operating within an organizational structure that is devoted to quality.

Giovenzana is an UNI EN ISO 9001:2008 certified company. Today, Giovenzana's goal is not only "to manufacture a quality product," but also to ensure the protection of our production cycle processes Giovenzana's Company is certificated UNI EN ISO 14001:2004.



GIOVENZANA

INTERNATIONAL B.V.

The Company

THE PRODUCTION

The solutions offered by **Giovenzana** are the results of the close examination of the requirements of industrial electrical accessories, and are in line with all relevant international standards. It comprises of three main sectors: Industrial automation, lift and lifting equipment.

AUTOMATION

Automation includes Phoenix cam switches from 12A to 630A and Regolus switch disconnectors from 25A to 160A; Pegasus control auxiliaries with screw or spring loaded terminal contact blocks; limit switches with die cast or molded casing and safety switches; foot switches and micro switches.

LIFT

Throughout the years, continuous technological research and development has made **Giovenzana** the undisputed leader in its field. The range includes: pit bottom push button stations, recall drive control units and inspection boxes.

LIFTING EQUIPMENT

Lifting equipment comprises of single and double row pendant stations up to 14 gang for control and direct switching power circuits, reversing switches, worm screen and rotary limit switches, slip rings, horns, festoon systems and conductor rails.





QUALITY

Giovenzana, leader in the elevator and lifting equipment field, has gained a prominent position in the automation sector with their launch of industrial control accessories into the market. For many years, all commercial and industrial operations are integrated within the frame of the UNI EN ISO 9001:2008 quality system.

CSQ certificate N 9105. GIOV.

Giovenzana has fulfilled its commitment to the quality of its products since 1995. The quality system is the end users guarantee that all production stages are maintained under strict control and adhere to the requirements set by the company both in terms of customer expectations and compliance to the relevant international standards as proved by the various certificates **Giovenzana** holds for its products. With the certification UNI EN ISO 14001:2004, **Giovenzana** keeps up with new technologies in order to reduce the consumption of raw materials, energy and natural resources and to minimize refuse and emissions in hopes of progressively reducing negative impacts on the environment, **Giovenzana products are in conformity to directives Rohs, Pfos, Raee and Reach.**

The certification CSQ N 9191. GIBV

COMPLIANCE

All **Giovenzana** products are manufactured according to the relevant Cee directives. **Giovenzana** certifies this compliance with a declaration of conformity.

CERTIFICATIONS

In order to reach the high level of quality **Giovenzana's** products achieve, they are tested by multiple third parties. In order to obtain the UL mark, **Giovenzana** submits their products to be tested by Underwriter Laboratories Inc., one of the most prestigious independent certification companies in the world.

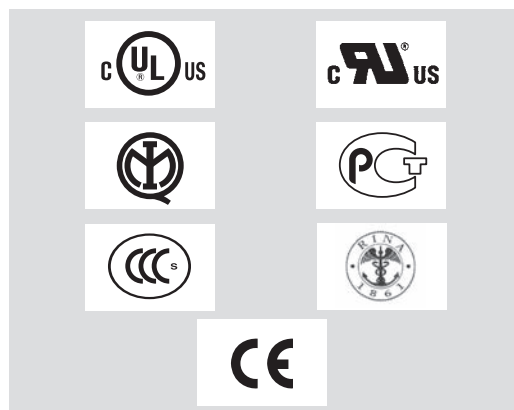

GIOVENZANA INTERNATIONAL B.V.

Certifications

CEE DIRECTIVES

As of January 1, 1997 it is compulsory to CE mark all electromechanical products: this has been outlined by two important regulations: 72/23 CEE and 93/68 CEE Low Voltage Directives.

CE MARK

European directives, applied to all national regulations, set the minimum requirements in term of safety of all electrical material sold within the EU. The compliance to these requirements is certified to the manufacturer by the CE mark placed on the products.

STANDARDS

Giovenzana's products comply with both the European EN and the American UL standards. These regulations, such as the EN 60024 (with regards to the safety requirements of the electrical circuits on board industrial machinery), define the characteristics, performance and use of the products.

EN EUROPEAN STANDARDS

The EN European standards usually originate from IEC International standards and are the result of the collaboration between CENELEC (European Committee for Electrotechnical Standardization) member countries. These standards cover and eliminate existing national standards that may be contradictory or out of date.





AUTOMATION

■ Phoenix cam switches	_____ pag.	11
■ Regulus switch-disconnectors	_____ pag.	39
■ Pegasus control auxiliaries	_____ pag.	71
■ Limit switches	_____ pag.	99
■ Micro switches	_____ pag.	124
■ Foot switches	_____ pag.	126

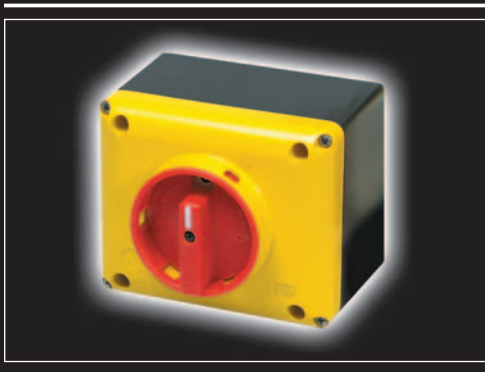
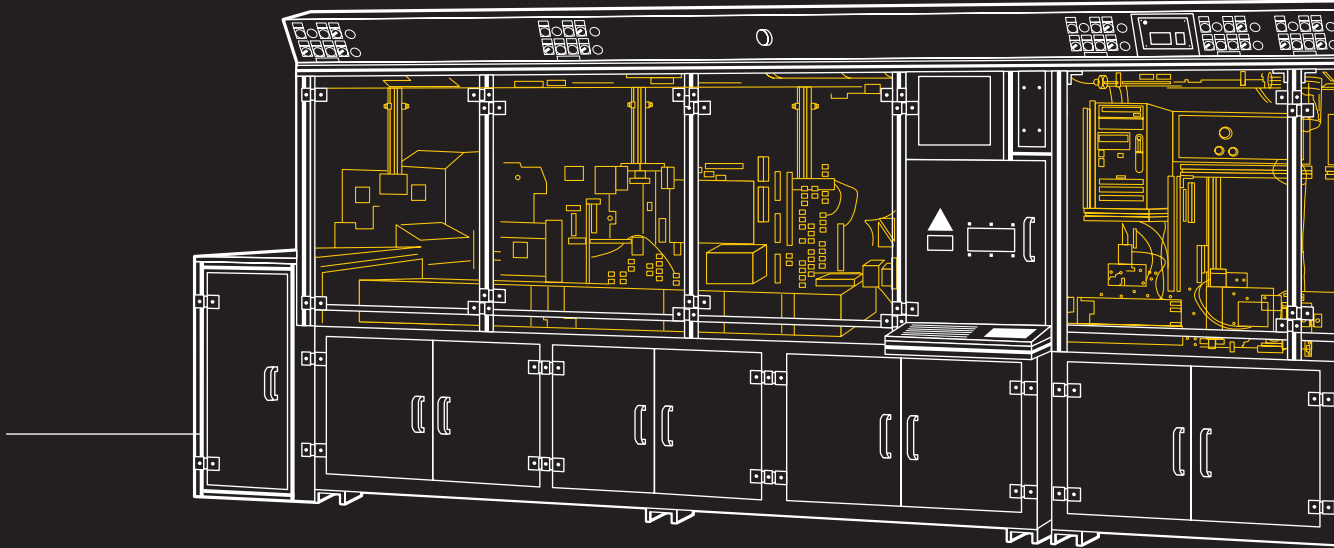

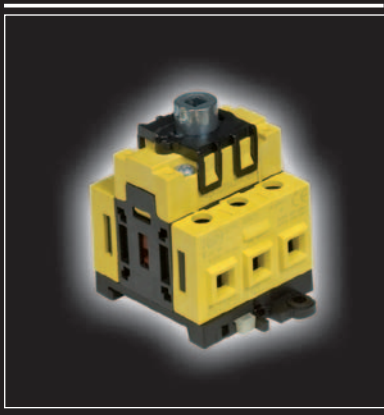
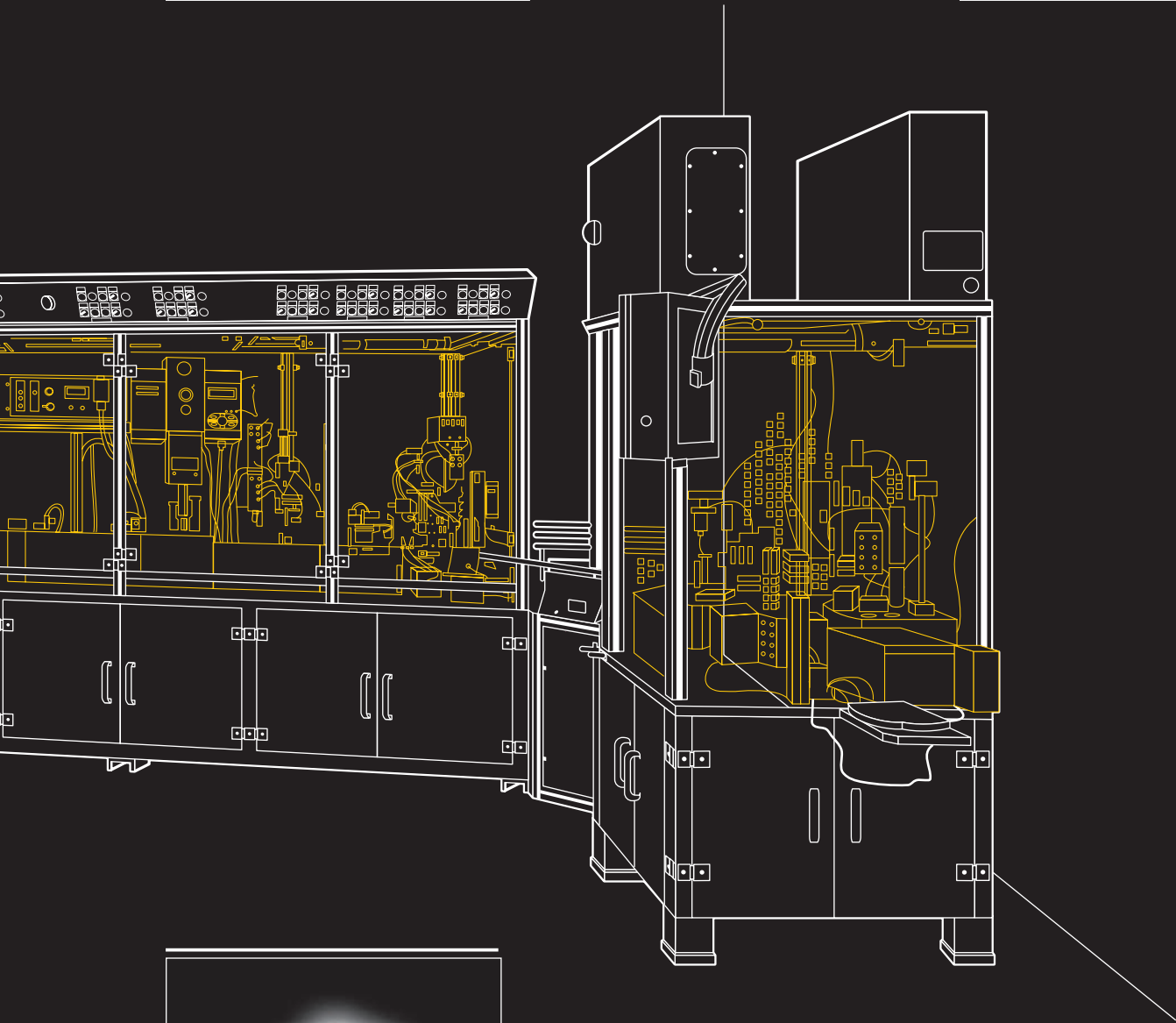
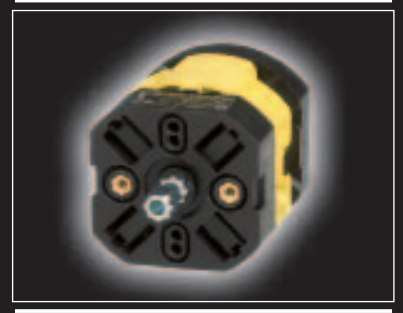
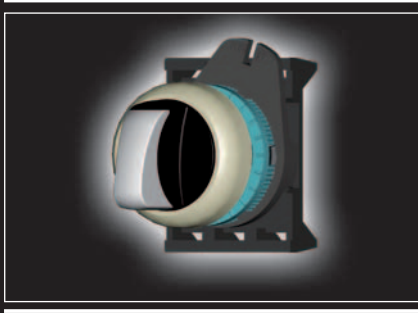

Phoenix

Cam switches

Table of contents



AUTOMATION TECHNOLOGIES



Current rating from 12A to 630A with Base, Din and panel mounting with fixing screws or \varnothing 22,5 mm holes. Wide range of circuit diagrams available. Special versions made to order.

TABLE OF CONTENTS

■ Range overview	pag. 12	■ Devices with screws fixing	pag. 23
■ Panel mounting switches: R	pag. 14	■ Panel mounting R	
■ Switches - changeover switches		■ Base mounting door interlock B	
■ Reversing switches	pag. 15	■ Devices with central fixing \varnothing 22	pag. 25
■ Motor changeover switches	pag. 16	■ Panel mounting R	
■ Instruments switches	pag. 17	■ Base mounting door interlock B	
■ 2 way switches and step switches	pag. 18	■ Devices with screws fixing and \varnothing 22 central	pag. 27
■ Base mounting switches: B	pag. 20	■ fixing panel mounting with special inscriptions	
■ Door interlock switches		■ Accessories	pag. 28
■ DIN rail mounting	pag. 22	■ Technical data	pag. 30
■ Instrumentation switches		■ Dimensions	pag. 34
		■ Fixing details	
		■ Blank circuit diagrams	pag. 38

Phoenix

Cam switches

Range overview

PO12 - PO16 - PO20 SERIES



- Panel mounting by means of horizontal fixing holes, 28 mm distance, for M3 screws or vertical fixing holes, 32 mm distance, for self tapping screws.
- Wafers secured by means of screws
- Metal shaft as standard
- IP20 rated terminals

PX12 - PX16 - PX20 SERIES

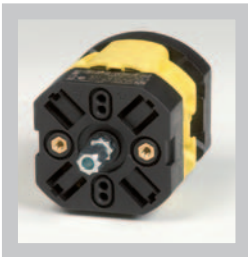

- Panel mounting by means of horizontal fixing holes, 28 mm distance, for M3 screws or vertical fixing holes, 32 mm distance, for self tapping screws.
- Wafers secured by means of screws
- Metal shaft as standard
- IP10 rated terminals for special applications

CO25 - CO32 - CO40 SERIES



- Panel mounting by means of horizontal fixing holes for M3 screws
- Wafers secured by means of screws
- Metal shaft as standard
- IP20 rated terminals

CX25 - CX32 - CX40 SERIES



- Panel mounting by means of horizontal fixing holes for M3 screws
- Wafers secured by means of screws
- Metal shaft as standard
- IP10 rated terminals for special applications

Phoenix

Cam switches

Range overview



AUTOMATION TECHNOLOGIES

CO63-CO80 SERIES



- Panel mounting by means of horizontal fixing holes 40 mm distance or on vertical fixing 46 mm with metrical screws M5
- Wafers secured by means of screws
- Standard metal shaft $\square 6$ mm
- Terminals with wiring clamp M4



C100 SERIES



- Panel mounting by means of vertical fixing holes 65 mm with metrical screws M5
- Wafers secured by means of screws
- Contacts 4 brakes
- Standard metal shaft $\square 8$ mm
- Terminals screw with wiring clamp M5
- Unic version for panel and base fixing



C200 SERIES

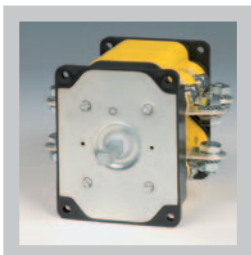

- Panel mounting by means of 4 holes 114x84 with metrical screws M6
- Wafers secured by means of screws
- Contacts 4 brakes
- Standard metal shaft $\square 10$ mm
- Terminals for cable lugs connections with head exagonal screws M10
- Unic version for panel and base fixing
- C400 - C630 Series



On demand are realized series C400 lth 400 and series C630 lth 630A

Phoenix

Panel mounting switches : R

Switches - changeover switches



SWITCHES



90°



60°

C100-C200 Series

02.....06

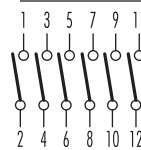

07



45°

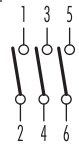

SERIES	NOM. CURRENT AC21A AMP.	1 POLE 1 WAFER	2 POLES 1 WAFER	3 POLES 2 WAFERS	4 POLES 2 WAFERS	5 POLES 3 WAFERS	6 POLES 3 WAFERS	3P WITH SPRIN RETURN 3 WAFERS
P012	12	P0120001R	P0120002R	P0120003R	P0120004R	P0120005R	P0120006R	P0120007R
P016	16	P0160001R	P0160002R	P0160003R	P0160004R	P0160005R	P0160006R	P0160007R
P020	20	P0200001R	P0200002R	P0200003R	P0200004R	P0200005R	P0200006R	P0200007R
C025	25	C0250001R	C0250002R	C0250003R	C0250004R	C0250005R	C0250006R	C0250007R
C032	32	C0320001R	C0320002R	C0320003R	C0320004R	C0320005R	C0320006R	C0320007R
C040	40	C0400001R	C0400002R	C0400003R	C0400004R	C0400005R	C0400006R	C0400007R
C063	63	-	C0630002R	C0630003R	C0630004R	-	C0630006R	-
C080	75	-	C0800002R	C0800003R	C0800004R	-	C0800006R	-
*C100	125	-	C1000002R	C1000003R	C1000004R	-	C1000006R	-
*C200	200	-	C2000002R	C2000003R	C2000004R	-	C2000006R	-

LINE CHANGEOVER SWITCHES



45°



60°

C100-C200 Series

08.....11

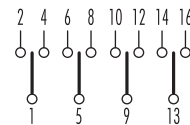

from 1 to 4 poles

SERIES	NOM. CURRENT AC21A AMP.	1 POLE 1 WAFER	2 POLES 2 WAFERS	3 POLES 3 WAFERS	4 POLES 4 WAFERS
P012	12	P0120008R	P0120009R	P0120010R	P0120011R
P016	16	P0160008R	P0160009R	P0160010R	P0160011R
P020	20	P0200008R	P0200009R	P0200010R	P0200011R
C025	25	C0250008R	C0250009R	C0250010R	C0250011R
C032	32	C0320008R	C0320009R	C0320010R	C0320011R
C040	40	C0400008R	C0400009R	C0400010R	C0400011R
C063	63	C0630008R	C0630009R	C0630010R	C0630011R
C080	75	C0800008R	C0800009R	C0800010R	C0800011R
*C100	125	C1000008R	C1000009R	C1000010R	C1000011R
*C200	200	C2000008R	C2000009R	C2000010R	C2000011R

* Series available also in base mounting version.

Phoenix

Panel mounting switches: R

Reversing switches - motor changeover switches



AUTOMATION TECHNOLOGIES



REVERSING SWITCHES

REVERSING AND REVERSING PHASE STARTER - SWITCHES

SERIES	NOM. CURRENT AC21A AMP.	3 POLES 3 WAFERS
P012	12	P0120012R
P016	16	P0160012R
P020	20	P0200012R
C025	25	C0250012R
C032	32	C0320012R
C040	40	C0400012R
C063	63	C0630012R
C080	75	C0800012R

12



45°

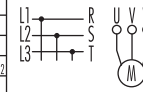
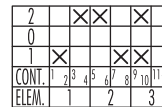
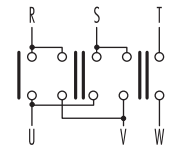

SERIES	NOM. CURRENT AC21A AMP.	3P WITH SPRING RETURN 3 WAFERS
P012	12	P0120013R
P016	16	P0160013R
P020	20	P0200013R
C025	25	C0250013R
C032	32	C0320013R
C040	40	C0400013R

13



45°

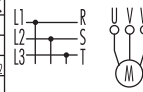
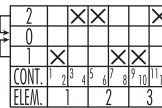
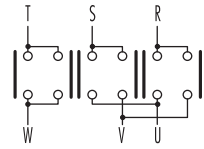

REVERSING SWITCH FOR SINGLE PHASE MOTOR WITH CENTRIFUGAL CUT-OUT

SERIES	NOM. CURRENT AC21A AMP.	3 WAFERS
P012	12	P0120016R
P016	16	P0160016R
P020	20	P0200016R
C025	25	C0250016R
C032	32	C0320016R
C040	40	C0400016R

16



45°

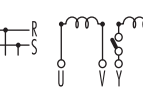
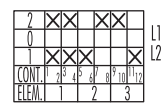
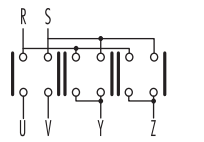

REVERSING SWITCH WITH AUXILIARY PHASE

SERIES	NOM. CURRENT AC21A AMP.	3 Wafers - REV. SWITCHES	3 Wafers - SWITCHES
P012	12	P0120018R	P0120017R
P016	16	P0160018R	P0160017R
P020	20	P0200018R	P0200017R

18



45°

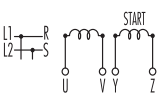
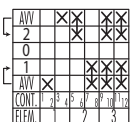
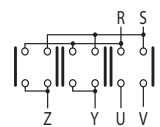

17

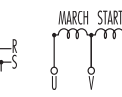
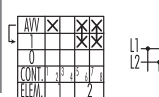
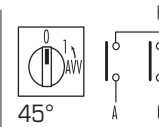

Phoenix

Panel mounting switches: R Motor changeover switches

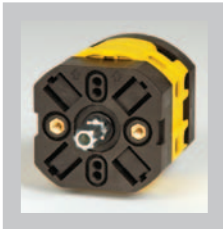

MOTOR CHANGEOVER SWITCHES

SERIES	NOM. POWER AC-23A kW-400V	DAHLENDER 2 SPEED SWITCH 3 WAFERS
PO12	5.5	PO120014R
PO16	7.5	PO160014R
PO20	9	PO200014R
CO25	11	CO250014R
CO32	15	CO320014R
CO40	18.5	CO400014R
CO63	22	CO630014R
CO80	30	CO800014R

14 Dahlander 2 speed switch

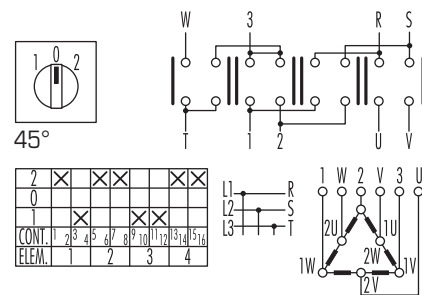

SERIES	NOM. POWER AC-23A kW-400V	STAR DELTA STARTER 4 WAFERS
PO12	5.5	PO120015R
PO16	7.5	PO160015R
PO20	9	PO200015R
CO25	11	CO250015R
CO32	15	CO320015R
CO40	18.5	CO400015R
C100	45	C1000015R

15 Star delta starter

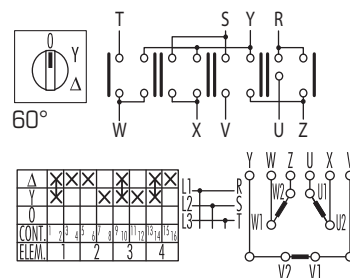

SERIES	NOM. POWER AC-23A kW-400V	POLARITY CHANGEOVER SWITCH WITH REVERSE FUNCTION 6 WAFERS
PO12	5.5	PO120031R
PO16	7.5	PO160031R
PO20	9	PO200031R
CO25	11	CO250031R
CO32	15	CO320031R
CO40	18.5	CO400031R

31 Polarity changeover switch with reverse function

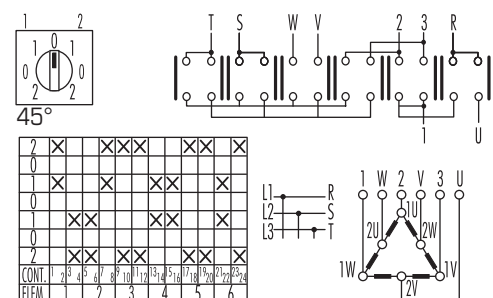



AMMETER SWITCHES

VOLTMETER SWITCHES

SERIES	NOM. CURRENT AC-21A AMP.	AMMETER 1 POLE FOR 3 CTS 3 WAFERS	19
P012	12	P0120019R	
P016	16	P0160019R	
P020	20	P0200019R	

SERIES	NOM. CURRENT AC-21A AMP.	VOLTMETER 3 PHASE TO NEUTRAL 2 WAFERS	20
P012	12	P0120020R	
P016	16	P0160020R	
P020	20	P0200020R	

SERIES	NOM. CURRENT AC-21A AMP.	VOLTMETER 3 PHASE CONCATENATED VOLTAGES 2 WAFERS	21
P012	12	P0120021R	
P016	16	P0160021R	
P020	20	P0200021R	

SERIES	NOM. CURRENT AC-21A AMP.	VOLTMETER 3 PHASE CONCATENATED VOLTAGES 2 CIRCUITS 4 WAFERS	22
P012	12	P0120022R	
P016	16	P0160022R	
P020	20	P0200022R	

SERIES	NOM. CURRENT AC-21A AMP.	VOLTMETER 3 PHASE CONCATENATED VOLTAGES 3 PHASE TO NEUTRAL 3 WAFERS	23
P012	12	P0120023R	
P016	16	P0160023R	
P020	20	P0200023R	

SERIES	NOM. CURRENT AC-21A AMP.	VOLTMETER 3 PHASE CONCATENATED VOLTAGES 1 PHASE TO NEUTRAL 3 WAFERS	24
P012	12	P0120024R	
P016	16	P0160024R	
P020	20	P0200024R	

Phoenix

Panel mounting bases : R

Changeover without off switches - step switches



CHANGEOVER WITHOUT OFF SWITCHES

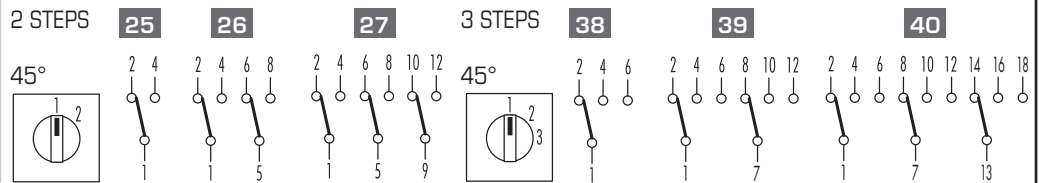

SERIES	NOM. CURRENT AC-21A AMP.	2 STEPS			3 STEPS		
		SINGLE POLE 1 WAFER	DOUBLE POLE 2 WAFERS	3 POLES 3 WAFERS	SINGLE POLE 2 WAFERS	DOUBLE POLE 3 WAFERS	3 POLES 5 WAFERS
P012	12	P0120025R	P0120026R	P0120027R	P0120038R	P0120039R	P0120040R
P016	16	P0160025R	P0160026R	P0160027R	P0160038R	P0160039R	P0160040R
P020	20	P0200025R	P0200026R	P0200027R	P0200038R	P0200039R	P0200040R

4 STEPS CHANGEOVER WITHOUT OFF SWITCHES

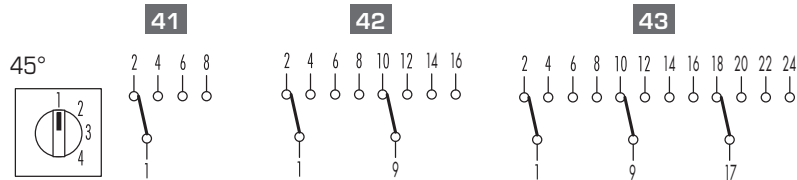

SERIES	NOM. CURRENT AC-21A AMP.	4 STEPS		
		SINGLE POLE 2 WAFERS	DOUBLE POLE 4 WAFERS	3 POLES 6 WAFERS
P012	12	P0120041R	P0120042R	P0120043R
P016	16	P0160041R	P0160042R	P0160043R
P020	20	P0200041R	P0200042R	P0200043R

MULTI WAY STEP SWITCHES WITH 0

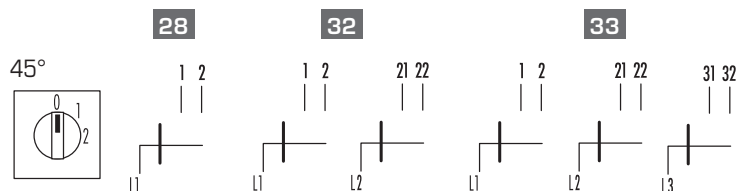

SERIES	NOM. CURRENT AC-21A AMP.	2 STEPS		
		SINGLE POLE 1 WAFER	DOUBLE POLE 2 WAFERS	3 POLES 3 WAFERS
P012	12	P0120028R	P0120032R	P0120033R
P016	16	P0160028R	P0160032R	P0160033R
P020	20	P0200028R	P0200032R	P0200033R



MULTI WAY STEP SWITCHES WITH "O"

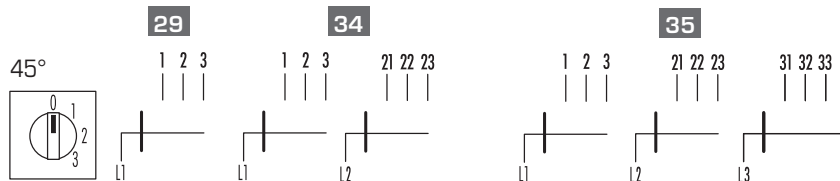

3 STEPS

SERIES	NOM. CURRENT AC-21A AMP.	SINGLE POLE 2 WAFERS	DOUBLE POLE 3 WAFERS	3 POLES 5 WAFERS
PO12	12	PO120029R	PO120034R	PO120035R
PO16	16	PO160029R	PO160034R	PO160035R
PO20	20	PO200029R	PO200034R	PO200035R



MULTI WAY STEP SWITCHES WITH "O"

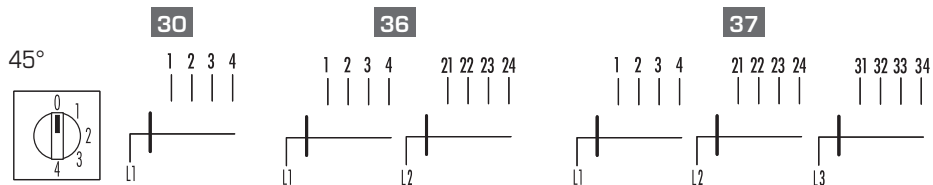

4 STEPS

SERIES	NOM. CURRENT AC-21A AMP.	SINGLE POLE 2 WAFERS	DOUBLE POLE 4 WAFERS	3 POLES 6 WAFERS
PO12	12	PO120030R	PO120036R	PO120037R
PO16	16	PO160030R	PO160036R	PO160037R
PO20	20	PO200030R	PO200036R	PO200037R

Phoenix

Box mounting base: B door interlock

On-Off switches



ON-OFF SWITCHES P012 - P016 - P020 Series

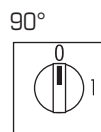
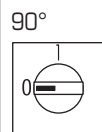

03 3 POLES



04 4 POLES



06 6 POLES

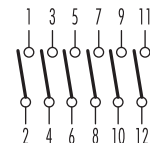

SERIES	NOM. CURRENT AC-21A AMP.	3 POLES 2 WAFERS	4 POLES 4 WAFERS	6 POLES 3 WAFERS
P012	12	P0120003B	P0120004B	P0120006B
P016	16	P0160003B	P0160004B	P0160006B
P020	20	P0200003B	P0200004B	P0200006B



ON-OFF SWITCHES C025 - CP032 - C040 Series

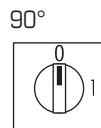
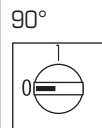

03 3 POLES



04 4 POLES

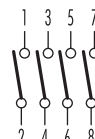

06 6 POLES

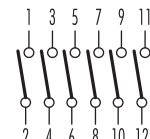

SERIES	NOM. CURRENT AC-21A AMP.	3 POLES 2 WAFERS	4 POLES 4 WAFERS	6 POLES 3 WAFERS
C025	25	C0250003B	C0250004B	C0250006B
C032	32	C0320003B	C0320004B	C0320006B
C040	40	C0400003B	C0400004B	C0400006B



ON-OFF SWITCHES C025 - CP032 - C040 Series

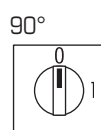
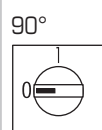

03 3 POLES



04 4 POLES



06 6 POLES

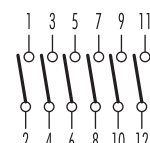

SERIES	NOM. CURRENT AC-21A AMP.	3 POLES 2 WAFERS	4 POLES 4 WAFERS	6 POLES 3 WAFERS
C063	63	C0630003B	C0630004B	C0630006B
C080	75	C0800003B	C0800004B	C0800006B

Phoenix

Box mounting base: B door interlock On-Off switches



AUTOMATION TECHNOLOGIES



ON-OFF SWITCHES C100 Series

60°



03 3 POLES



04 4 POLES

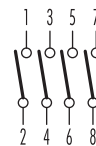

06 6 POLES

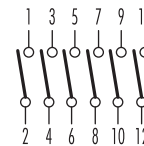

SERIES	NOM. CURRENT AC-21 AMP.	3 POLES 2 WAFERS	4 POLES 4 WAFERS	6 POLES 3 WAFERS
C100	125	C1000003R	C1000004R	C1000006R

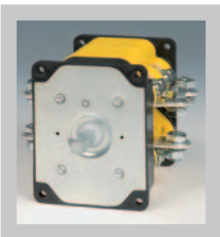

ON-OFF SWITCHES C200 Series

60°



03 3 POLES



04 4 POLES

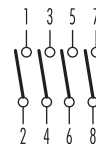

06 6 POLES

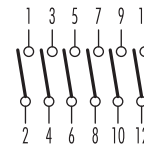

SERIES	NOM. CURRENT AC-21 AMP.	3 POLES 2 WAFERS	4 POLES 4 WAFERS	6 POLES 3 WAFERS
C200	200A	C2000003R	C2000004R	C2000006R

C100 - C200 Series are arranged in one execution one code for R and B fixing type.

Phoenix

Complete switches Base-DIN rail mounting for standardised enclosures
On-Off switches - Instrumentation switches



ON-OFF SWITCHES

DIN rail mounting for 46 mm. standardised enclosures

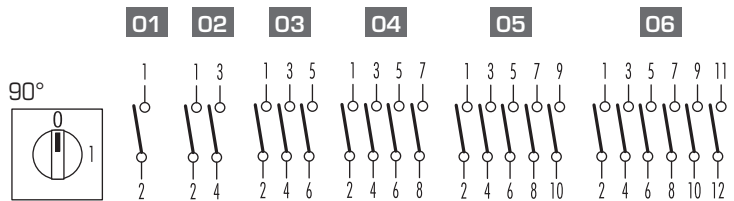

SERIES	NOM. CURRENT AC-21A AMP.	SINGLE POLE 3 WAFERS	DOUBLE POLE 3 WAFERS	3 POLES 3 WAFERS	4 POLES 3 WAFERS	5 POLES 3 WAFERS	6 POLES 3 WAFERS
PO12	12	PO120001D027	PO120002D027	PO120003D027	PO120004D027	PO120005D027	PO120006D027
PO16	16	PO160001D027	PO160002D027	PO160003D027	PO160004D027	PO160005D027	PO160006D027

CHANGEOVER SWITCHES

SERIES	NOM. CURRENT AC-21A AMP.	AMMETER 1 POLE FOR 3 CTS 3 WAFERS	19
PO12	12	PO120019D027	
PO16	16	PO160019D027	

SERIES	NOM. CURRENT AC-21A AMP.	VOLTMETER 3 PHASE TO NEUTRAL 3 WAFERS	20
PO12	12	PO120020D027	
PO16	16	PO160020D027	

SERIES	NOM. CURRENT AC-21A AMP.	VOLTMETER 3 PHASE CONCATENATED VOLTAGES 3 WAFERS	21
PO12	12	PO120021D027	
PO16	16	PO160021D027	

SERIES	NOM. CURRENT AC-21A AMP.	VOLTMETER 3 PHASE CONCATENATED VOLTAGES 3 PHASE TO NEUTRAL 3 WAFERS	23
PO12	12	PO120023D027	
PO16	16	PO160023D027	

SERIES	NOM. CURRENT AC-21A AMP.	VOLTMETER 3 PHASE CONCATENATED VOLTAGES 1 PHASE TO NEUTRAL 3 WAFERS	24
PO12	12	PO120024D027	
PO16	16	PO160024D027	

Phoenix

Screw fixing plates - panel mounting R



AUTOMATION TECHNOLOGIES

EN60529 - IP65 UL50 1 - 4 - 4x (*) NEMA 4X Protection



Grey plate
Black knob

- 48 **001/.....** 88 **201/.... - 241/....**
- 64 **007/.....** 130 **261/.....**

SERIES	PLATE	90°		45°		45°		45°		60°		45°	
		01.....06	01.....06	07	08....12-14-16	13	15	17					
P012	<input type="checkbox"/> 48	001/0001	001/0001-1	001/0007	001/0008	001/0013	001/0015	001/0017					
P020													
C025													
C032	<input type="checkbox"/> 64	007/0001	007/0001-1	007/0007	007/0008	007/0013	007/0015	007/0017					
C040													
C063	<input type="checkbox"/> 88	201/0001	201/0001-1	-	201/0008	-	-	-					
C080													
*C100	<input type="checkbox"/> 88	-	241/0001-1 [□]	-	241/0008 [□]	-	241/0015	-					
*C200	<input type="checkbox"/> 130	-	261/0001-1 [□]	-	261/0008 [□]	-	-	-					

SERIES	PLATE	45°		90°		45°		45°		45°		45°	
		18	19	24	20	21	22	23					
P012													
P016	<input type="checkbox"/> 48	001/0018	001/0019	001/0024	001/0020	001/0021	001/0022	001/0023					
P020													
C025													
C032	<input type="checkbox"/> 64	007/0018	007/0019	007/0024	007/0020	007/0021	007/0022	007/0023					
C040													











SERIES	PLATE	45°		45°		45°		45°		45°	
		25-26-27	38-39-40	41-42-43	28-32-33	29-34-35	30-36-37	31			
P012...020	<input type="checkbox"/> 48	001/0025	001/0038	001/0041	001/0028	001/0029	001/0030	001/0031			
C025...040	<input type="checkbox"/> 64	007/0025	007/0038	007/0041	007/0028	007/0029	007/0030	007/0031			

C100 - C200 60° switch

Phoenix

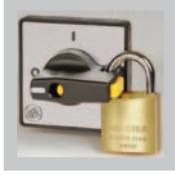
Screws fixing plates - Panel mounting R Door locking B

EN60529 - IP65 UL50 1 - 4 - 4x (*) NEMA 4X Protection

				PANEL MOUNTING		DOOR LOCKING		
		SERIES	PLATES					
	Grey plate round Black knob	P012....P020	□ 48	001/0001	001/0001-1	020/0001	-	
		C025....C040	□ 64	007/0001	007/0001-1	-	-	
		C63....C80	□ 88	201/0001	201/0001-1	220/0001	-	
		C100	□ 88	-	241/0001-1□	-	-	
		C200	□ 130	-	261/0001-1□	-	-	
	Yellow plate round Red knob	P012....P020	□ 48	002/0001	002/0001-1	-	-	
		C025....C040	□ 64	008/0001	008/0001-1	-	-	
	Grey plate round Black knob With looking facility	P012....P020	□ 48	-	003/0001-1	*005/0001	-	
		C025....C040		*003/0001	-			
	Yellow plate round Red knob With looking facility	P012....P020	□ 48	-	*004/0001-1	*006/0001	-	
		C025....C040		*004/0001	-			
	Grey plate round Black knob With looking facility (max.3)	P012....P020	□ 67	*009/0001	*009/0001-1	*011/0001	*011/0001-A	
		C025....C040		□ 67	*009/0001	*009/0001-1	*011/0001	*011/0001-A
		C63....C80		□ 92	209/0001	209/0001-1	211/0001	211/0001-1
		C100		□ 92	-	249/0001-1□	-	251/0001-1□
		C200		□ 130	-	269/0001-1□	-	271/0001-1□
	Yellow plate round Red knob With looking facility (max.3)	P012....P020	□ 67	*010/0001	*010/0001-1	*012/0001	*012/0001-2	
		C025....C040		□ 67	*010/0001	*010/0001-1	*012/0001	*012/0001-2
		C63....C80		□ 92	210/0001	210/0001-1	212/0001	212/0001-1
		C100		□ 92	-	250/0001-1□	-	252/0001-1□
		C200		□ 130	-	270/0001-1□	-	272/0001-1□

□ C100 - C200 60° switch

Phoenix

Panel mounting Ø 22 mm hole Panel mounting R



AUTOMATION TECHNOLOGIES

EN60529 - IP65 UL50 1 - 4 - 4x (*) NEMA 4X Protection



Panel mounting Ø 22 mm hole
Grey plate
Black knob
□ 48

056

Panel mounting Ø 22 mm hole
Grey plate
with key
□ 48

057



SERIES	TYPE	90°		90°		45°		90°		45°		45°	
		01.....06	01.....06	08.....12-14-16	19	20	21						
P012	with knob	056/0001	056/0001-1	056/0008	056/0019	056/0020	056/0021						
P016													
P020	with key *	057/0001	057/0001-1	057/0008-CA	-	-	-						

SERIES	TYPE	45°		45°		45°		45°		45°		45°	
		22	23	24	25....27	38...40	41....43						
P012	with knob	056/0022	056/0023	056/0024	056/0025	056/0038	056/0041						
P016													
P020	with key *	-	-	-	-	-	-						

SERIE	TIPO	45°		45°		45°							
		28-32-34	29-34-35	30-36-37									
P012	with knob	056/0028	056/0029	056/0030									
P016													
P020	with key *	057/0028-CA	057/0029-CA	-									



Panel mounting Ø 22 mm hole
with knob
028

Panel mounting Ø 22 mm hole
with key
029

Key removal at position
0° and 180°

























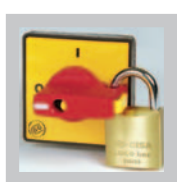



P012-P016-P020	028	029
----------------	-----	-----

* Key removal at "0" position

Phoenix

Panel mounting Ø 22 mm hole Panel mounting R - door locking B

EN60529 - IP65 UL50 1 - 4 - 4x (*) NEMA 4X Protection

				PANEL MOUNTING		DOOR LOCKING	
	Grey plate round Black knob	SERIES P012....P020 C025.....C040	PLATE □ 48				
				056/0001	056/0001-1	095/0001	-
	Yellow plate round Red knob	SERIES P012....P020 C025.....C040	PLATE □ 48				
				058/0001	058/0001-1	070/0001	-
	Grey plate round Black knob With looking facility	SERIES P012....P020 C025.....C040	PLATE □ 48				
				059/0001	-	* 077/0001	-
	Yellow plate round Red knob With looking facility	SERIES P012....P020 C025.....C040	PLATE □ 48				
				060/0001	060/0001-1	* 069/0001	-
	Grey plate round Black disc type knob With looking facility (max.3)	SERIES P012....P020 C025.....C040	PLATE □ 67				
				061/0001	061/0001-1	* 063/0001	* 063/0001-1
	Yellow plate round Red disc type knob With looking facility (max.3)	SERIES P012....P020 C025.....C040	PLATE □ 67				
				062/0001	062/0001-1	* 064/0001	* 064/0001-1

Phoenix

Panel mounting Ø 22 mm hole Panel mounting R - Special plates



AUTOMATION TECHNOLOGIES

EN60529 - IP65 UL50 1 - 4 - 4x (*) NEMA 4X Protection



Screw fixing
Grey plate
Black knob

48 **001**
 64 **007**

Panel mounting Ø 22 mm hole plate

Grey plate
Black knob

48 **056**



45° SWITCHING
ANGLE

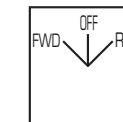
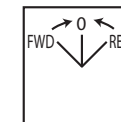
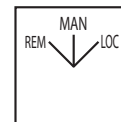
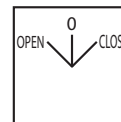
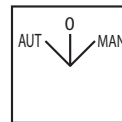
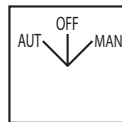
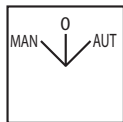

PLATE	FIXING	45°	45°	45°	45°	45°	45°	45°
		<input type="checkbox"/> 48	SCREW FIXING Ø 22 MM HOLE	001/0008-1	001/0008-4	001/0008-14	001/0840	-
<input type="checkbox"/> 64	SCREW FIXING	-	007/1481	-	-	056/0008-3	-	007/0008-1

45° SWITCHING
ANGLE

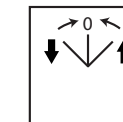
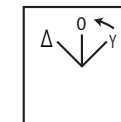
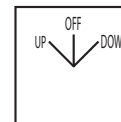
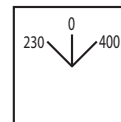
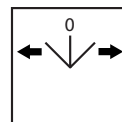
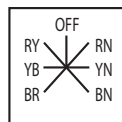
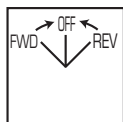

PLATE	FIXING	45°	45°	45°	45°	45°	45°	45°
		<input type="checkbox"/> 48	SCREW FIXING Ø 22 MM HOLE	-	001/0023-2	001/0949	001/0845	-
<input type="checkbox"/> 64	SCREW FIXING	007/0013-2	007/1135	-	-	007/0008-2	007/0354	-

90° SWITCHING
ANGLE

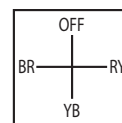
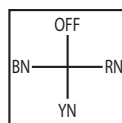
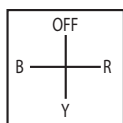

PLATE	FIXING	90°	90°	90°
		<input type="checkbox"/> 48	SCREW FIXING Ø 22 MM HOLE	-
<input type="checkbox"/> 64	SCREW FIXING	007/1131	007/1133	007/1132

Phoenix

Cam switches

Accessories

IP65 THERMOPLASTIC ENCLOSURES



FOR FRONT KNOB AND PANEL MOUNTING SWITCHES: R

Black box - grey cover
RAL 7035
Dimension 120x100x83 mm
Nr. 8 knock-outs Pg.

PO12 - PO16 - PO20 Series

Max. 3 wafers

BF1/2NGO

CO25 - CO32 - CO40 Series

Max. 2 wafers

BF1/6NGO

FOR SIDE KNOB AND PANEL MOUNTING SWITCHES: R

Black box - grey cover
RAL 7035
Dimension 120x100x83 mm
Nr. 8 knock-outs Pg.

PO12 - PO16 - PO20 Series

Max. 6 wafers

BL1/ONGO

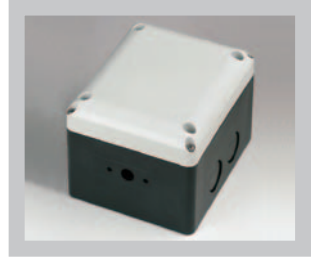

FOR FRONT KNOB AND PANEL MOUNTING SWITCHES: R

Black box - grey cover
RAL 7035
Dimension 130x180x106 mm.
Nr. 4 knock-outs M25/M32 +
nr. 2 ø 22 mm closed hole on
the bottom

CO25 - CO32 - CO40 Series

Max. 3 wafers

BF4/GNGO

CO63 - CO80 Series

Max. 2 wafers

BF4/HNGO

FOR PROTECTED FRONT KNOB AND PANEL MOUNTING SWITCHES: R

Black box - grey cover
RAL 7035
Dimension 75x75x60 mm.
Nr. 4 knock-outs M20

PO12 - PO16 - PO20 Series

Max. 3 wafers

PROTECTED COVER WITH HANDLE

PQCPGN

FLAT COVER

PQCOGN



IP65 ALUMINIUM ENCLOSURES

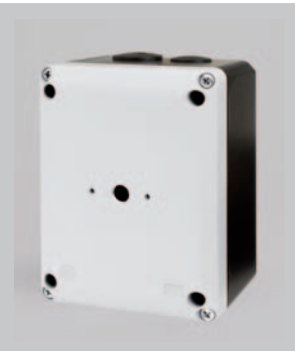

FOR FRONT KNOB AND PANEL MOUNTING SWITCHES: R

Black box - grey cover
RAL 7035
Dimension 105x140x85 mm.
Complete with nr. 2 M25
and nr. 2 M20 taps

PO12 - PO16 - PO20 Series

Max. 3 wafers

BFA/ANGO

CO25 - CO32 - CO40 Series

Max. 2 wafers

BFA/BNGO



PROTECTION

BOOT PROTECTION



SERIES	N° OF WAF.	DIAM.	CODE
PO12.....PO20	Max.3	65	11706031
CO25.....CO40	Max.3	85	20101005

BOOT PROTECTION ADAPTER



SERIES	N° OF WAF.	DIAM.	CODE
PO12.....PO20	2 Ele.	65	11702038
CO25.....CO40	2 Ele.	85	11706332

SOFT PROTECTION



SERIES	N° OF WAF.	DIAM.	CODE
PO12.....PO20	Max.3	65	20101007

Phoenix

Cam switches

Accessories



AUTOMATION TECHNOLOGIES

KNOB

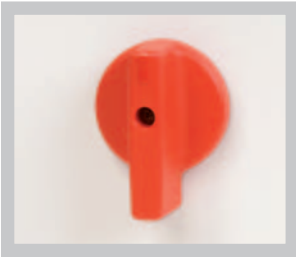

SERIES	CODE	COLOR
P012...C040	072	Black
	073	Red
C063...C080	218	Black
	219	Red

LONG KNOB



SERIES	CODE	COLOR
P012...C040	081	Black
	110	Red
-	-	-
-	-	-

LEVER



SERIES	CODE	COLOR
C100 □8	240	Black
C200 □10	260	Black

ROUND KNOB



SERIES	Ø	CODE	COLOR
P012...C040	34	018	Black
	34	111	Red
P012...C040	40	040	Black
	40	112	Red

GASKETS

For panel mounting R with knob only



SERIES	CODE
P012...P020	28000012



SERIES	CODE
C025...C040	15000015



SERIES	CODE
C063...C080	15010016

5 MM SQUARE LONG SHAFT

For panel mounting B door locking

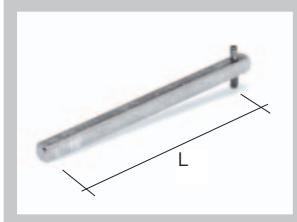

SERIES	L/mm	CODE
P012...P020	185	20401089
C025...C040	300	20401164

6 MM SQUARE LONG SHAFT

For panel mounting B door locking

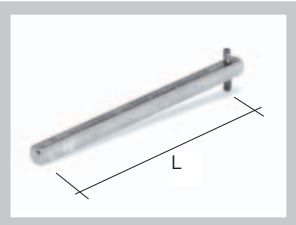

SERIES	L/mm	CODE
C063...C080	300	20900029
C100 □8	200	254
C200 □10	200	274

EXECUTIONS ON DEMAND

Fast on connections

Flat fast on terminals
Single or double terminals
From 6,3x0,8 or double
6,3x0,8 2 2,8x0,8
P012...P020 Series



Unidirectional turn

Unidirectional turn
C025...C040 Series



Axial interlock

"push and turn" interlock in
several positions
C025...C040 Series



Special shafts

Length and shape
on request



Phoenix

Characteristics

Electrical

EN 60947-3 CHARACTERISTICS				P012 - PX12	P016 - PX16
Rated operating voltage Ue		V		690	690
Rated insulation voltage Ui		V		690	690
Rated impulse withstand voltage Uimp (sectionable)		kV		4	4
Rated thermal current Ith		A		16	20
Rated thermal current in enclosed Ithe		A		12	16
Frequency		Hz		50/60	50/60
RATED OPERATING CURRENT Ie: alternate current					
AC-21A Switching resistive loads (☐) with light overloads		690V	A	12	16
AC-22A Switching mixed resistive and inductive loads at light overloads		690V	A	12	16
AC-23A Periodic switching of motors (☐)	single phase - 1 pole	110V	A/kW	12/1,1	14/1,5
		230V	A/kW	12/2,2	14/3
		230V	A/kW	10/3	13/4
	3 phase - 3 pole	400V	A/kW	10/5,5	13/7,5
		500V	A/kW	10/7,5	14/10
		690V	A/kW	10/7,5	14/10
AC3 Starting of cage motors (interruption while running)	single phase - 2 pole	110V	A/kW	10/0,75	12/1,1
		230V	A/kW	10/2	12/2,2
		230V	A/kW	8/2,2	10/3
	3 phase - 3 pole	400V	A/kW	8/4	10/5,5
		500V	A/kW	8/5,5	10/7,5
		690V	A/kW	6/5,5	8/7,5
RATED OPERATING CURRENT Ie: direct current					
DC-21A Switching resistive loads with light overloads	50V (1 phase)		A	10	12
DC-22A Switching mixed resistive and inductive loads at light overloads	30V (1 phase)		A	8	10
Nominal interruption power AC-23A (cosφ 0.45)	230V	A		80	104
	400V	A		80	104
	500V	A		80	112
	690V	A		80	112
Power dissipation per each phase			W	0,3*	0,35*
SHORT CIRCUIT CHARACTERISTICS					
Rated short-time short circuit withstand current Icw (1s)			A	300	300
Rated short circuit making capacity Icm			A	1200	1200
Conditional rated short circuit withstand current			kA	5	5
Fuse rating gG	690V		A	20	20
UL 508 CHARACTERISTICS					
General Use	600V ac		A	12	16
Standard motors load	single phase - 2 poles	120V ac	HP(FLA)	0,5 (9,8)	1 (16)
		240V ac	HP(FLA)	1 (8)	1,5 (10)
		200V ac	HP(FLA)	1,5 (9)	3 (14,4)
	3 phase - 3 poles	240V ac	HP(FLA)	3 (9,6)	5 (15,2)
		480V ac	HP(FLA)	5 (7,6)	7,5 (11)
		600V ac	HP(FLA)	5 (6,1)	7,5 (9)

* Values not reported on the IMG file ☐ Series C100 - C200 AC-21 - AC-23

Phoenix

Characteristics

Electrical



AUTOMATION TECHNOLOGIES

PO20 - PX20	CO25 - CX25	CO32 - CX32	CO40 - CX40	CO63	CO80	C100	C200
690	690	690	690	690	690	690	690
690	690	690	690	690	690	690	690
4	6	6	6	8	8	8	8
25	32	40	50	85	100	125	250
20	25	32	40	85	100	125	200
50/60	50/60	50/60	50/60	50/60	50/60	50/60	50/60
20	25	32	40	63	80	125	250
20	25	32	40	63	80	-	-
18/2	25/2,2	30/2,5	35/3	45/4	63/5,5	-	-
18/4	25/4,5	30/5,5	35/6,5	45/7,5	63/11	70/13	108/20
16/5	25/7,5	30/9	35/11	50/15	58/18,5	94/30	175/55
16/9	22/11	27/15	32/18,5	40/22	54/30	81/45	162/90
16/11	22/15	27/18,5	32/22	40/30	54/37	80/55	158/110
16/12,5	20/15	22/18,5	25/22	32/30	40/37	-	-
16/1,5	22/2	25/2,2	30/2,5	36/3	45/4	-	-
16/3,5	22/3,7	25/4	30/5,5	35/6,5	45/7,5	82/15	130/24
12/4	18/5,5	23/7,5	27/9	37/11	47/15	97/31	144/46
12/6,5	18/9	23/11	27/15	35/18,5	44/22	67/37	139/77
12/8	18/11	23/15	27/18,5	35/22	44/30	53/37	85/59
10/9	14/11	18/15	20/18,5	25/22	32/30	-	-
16	20*	25*	32*	-	-	-	-
12	16*	20*	25*	-	-	-	-
128	200	240	280	400	464	-	-
128	176	216	256	320	432	648	1296
128	176	216	256	320	432	-	-
128	160	176	200	256	320	-	-
0,4*	-	-	-	-	-	-	-
300	500	500	500	1200	1200	2000	4000
1200	2840	2840	2840	2000	2000	-	-
5	10	10	10	10	10	-	-
20	40 *	40 *	40 *	100	100	-	-
20	25	32	40	63	85	-	-
1,5 (20)	1,5(20)	2 (24)	3 (34)	5 (56)	5(56)	-	-
2 (12)	3 (17)	5 (28)	5 (28)	7,5 (40)	10 (50)	-	-
5 (22,8)	7,5 (25,3)	7,5 (25,3)	10 (32,2)	-	-	-	-
5 (15,2)	7,5 (22)	7,5 (22)	10 (28)	15 (42)	20 (54)	-	-
10 (14)	15 (21)	20 (27)	20 (27)	30 (40)	40 (52)	-	-
10 (11)	15 (17)	20 (22)	20 (22)	40 (41)	50 (52)	-	-

* Fuses type gG 40a 500V

Phoenix

Technical data

General characteristics

■	Comply with rules		
■	Protection class control	control control with knob only terminals terminals PX e CX series	EN60529 (UL50*) NEMA 4X
■	Material group		EN60947-1
■	Pollution grade		EN60947-1
■	Flammability		UL 94
■	Ambient temperature		°C °C
■	Climate withstand		IEC68 part 2-3 IEC68 part 2-30
■	Terminal screw identification		
■	Connections:		
■	Terminal block caliber		EN60947-1
■	Terminal screw		
■	Screwing torque		EN60947-1 UL508
■	Connectable section:		
	Flexible conductors min/max		mm ² AWG
	Solid conductors min/max		mm ² AWG
■	Contacts		
	Opening angles		
	Mechanical lifetime at 120 operations per hour		mil./cl
	Electrical lifetime at 120 operations per hour	AC21	mil./cl

CERTIFICATIONS

-  CE mark – Europa
-  cUL Listed – USA and Canada
-  Istituto Marchio Qualità (IMQ) – Italia
-  CCC Cina
-  GOST Russia

* See p/n device

Phoenix

Characteristics

General



AUTOMATION TECHNOLOGIES

IEC947-3, EN60947-3, UL508						IEC947-3, EN60947-3, UL508				
P012 - P016 - P020 PX12 - PX16 - PX20			C025 - C032 - C040 CX25 - CX32 - CX40			C063 - C080		C100	C200	
IP65 (Type 1 - 4 - 4X)			IP65 (Type 1 - 4 - 4X)			IP65		IP65	IP65	
IP40			IP40			IP40		-	-	
IP20			IP20			IPOO		IPOO	IPOO	
IP10			IP10			-		-	-	
II			II			II		I	I	
3			3			3		3	3	
VO: Live Parts						VO: Live Parts				
Operating: -25 +55						Operating: -25 +40				
Storage: -30 +70						Storage: -25 +60				
Hot Damp						Hot Damp				
Unsettled hot damp						Unsettled hot damp				
EN50013						EN50013				
A3			A5			A8		A8	-	
M 3,5			M4			2xM 4		2xM5	screws TE M10x20	
0,8 Nm (7,2 lb. in.)			1,2 Nm (10,6 lb. in.)			1,2 Nm (10,6 lb. in.)		2 Nm (18 lb. in.)	for rope terminals	
7,5 lb. in. (0,85 Nm)			12 lb in. (1,4 Nm)			10,62 lb. in. (1,2 Nm)		-	-	
1x0,75/4 - 2x0,75/2,5			2x2,5/10			2,5/35		6/35	-	
16-12			14-6			14/3		8/2	-	
1x0,75/4 - 2x0,75/2,5			2X2,5/10			2,5/35		10/35	-	
16-12			14-6			14/3		8/2	-	
Double gap contacts with positive opening action						Double contacts with double breaking				
30° - 45° - 60° - 90°			30° - 45° - 60° - 90°			45° - 60° - 90°		45° - 60° - 90°	45° - 60° - 90°	
1	1	1	1	1	1	1	1	0,5	0,5	
1	0,75	0,75	1	0,75	0,75	0,5	0,25	0,1	0,1	
P012 PX12	P016 PX16	P020 PX20	C025 CX25	C032 CX32	C040 CX40	C063	C080	C100	C200	
■	■	■	■	■	■	■	■	■	■	
●	●	●	●	●	●	●	●			
●	●	●	●	●	●	●	●			
●	●	●	●	●	●					
●	●	●	●	●	●					

■ Meets or exceed the minimum requirement

● Certified

Phoenix

Dimensions

Fixing details

PANEL MOUNTING SWITCHES: R

FIXING HOLES

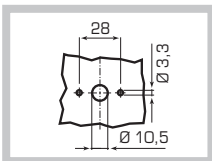

SERIES PO12 - P016 - P020
PX12 - PX16 - PX20

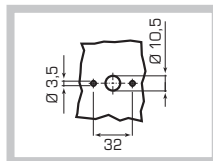

SERIES CO25 - C032 - C040
CX25 - CX32 - CX40

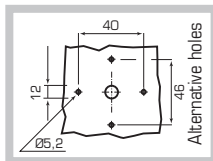

SERIES CO63 - C080

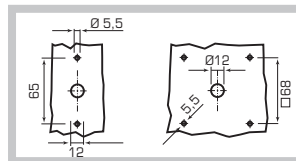

SERIES C100

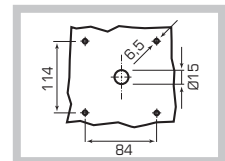

SERIES C200

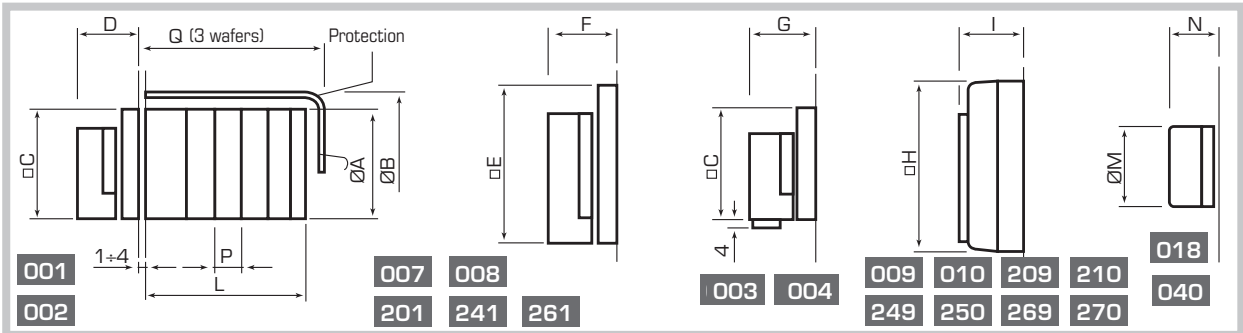

L x WAFERS No.

SERIES	1	2	3	4	5	6	P	A	B	C	D	E	F	G	H	I	M	N	Q
PO12 - P016 - P020	39	51,7	64,4	77,1	89,8	102,5	12,7	45	63	48	30,2	64	30,2	35,2	67	30,2	34	18,8	80
CO25 - C032 - C040	41,5	59	76,5	94	111,5	129	17,5	62	85	48	30,2	64	30,2	35,2	67	30,2	40	20,5	102
CO63 - C080	58,3	84,3	110,3	136,3	162,3	188,3	26	82	-	-	-	88	44	-	92	44	-	-	-
C100	69	97	125	153	181	209	28	84	-	-	-	88	38	-	92	56	-	-	-
C200	89	129	169	209	249	289	40	100x130	-	-	-	130	55	-	130	62	-	-	-

PANEL MOUNTED WITH DIAM. 22,5 HOLE

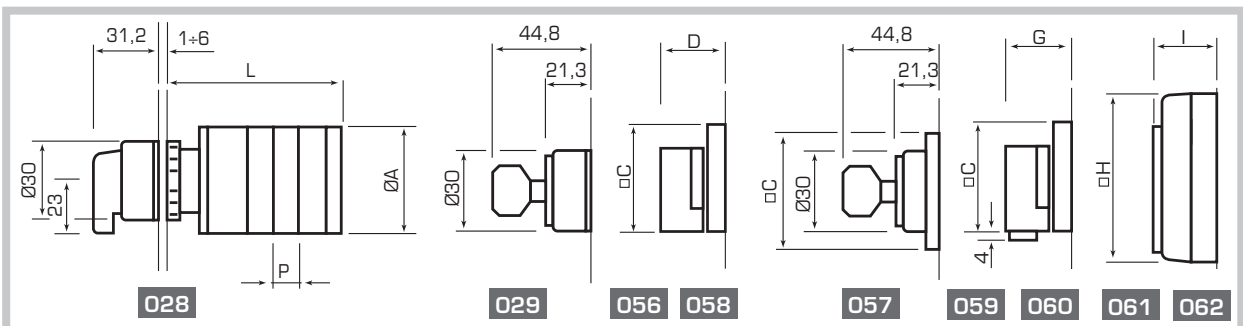

FIXING HOLE

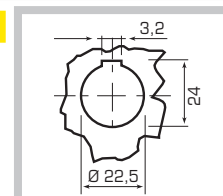

L x WAFERS No.

SERIES	1	2	3	4	5	6
PO12 - P016 - P020 PX12 - PX16 - PX20	58,2	70,9	83,6	96,3	109	121,7

For the Series PX and CX, are valid the fixing holes and the dimensions of PO and CO Series.

Phoenix

Dimensions

Fixing details



AUTOMATION TECHNOLOGIES

BASE MOUNTING FOR DOOR INTERLOCK - PANEL MOUNTING B

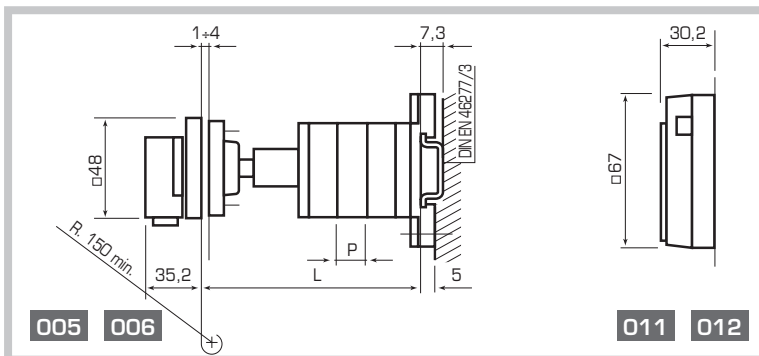

L x WAFERS No. WITH SHAFT AS STANDARD

SERIES	L x WAFERS No. WITH SHAFT AS STANDARD							
		1	2	3	4	5	6	P
P012 - P016 - P020	min*	74,7	87,4	100,1	112,8	125,5	138,2	12,7
PX12 - PX16 - PX20	max	132,7	145,4	158,1	170,8	183,5	196,2	

FIXING HOLE

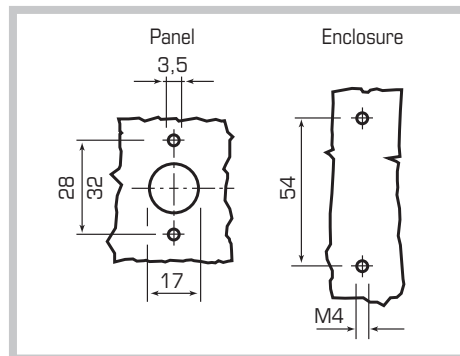

L x WAFERS No. WITH SHAFT EXTENSION 185 mm (ref. 20401089)

	L x WAFERS No. WITH SHAFT EXTENSION 185 mm (ref. 20401089)						
		1	2	3	4	5	6
min*	74,7	87,4	100,1	112,8	125,5	138,2	
max	232,7	245,4	258,1	270,8	283,5	296,2	

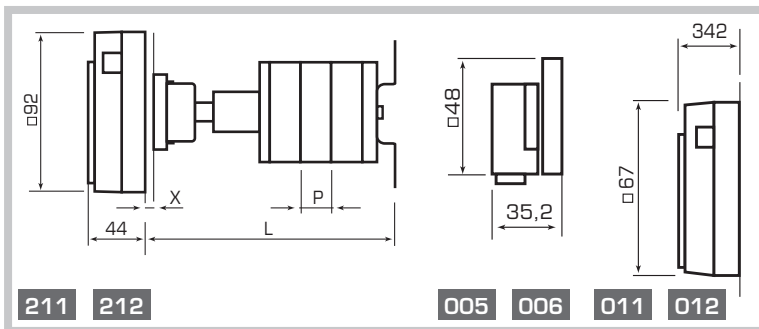

L x WAFERS No. WITH SHAFT AS STANDARD

SERIES	L x WAFERS No. WITH SHAFT AS STANDARD						
		1	2	3	4	P	X
C025 - C032 - C040	min*	94,5	112	129,5	147	17,5	1 ÷ 4
CX25 - CX32 - CX40	max	152,5	170	187,5	205		
C063 - C080	min*	129	155	181	207	26	1 ÷ 10
	max	177	203	229	255		

* L minimum length with cut shaft

DRILLING TEMPLATE

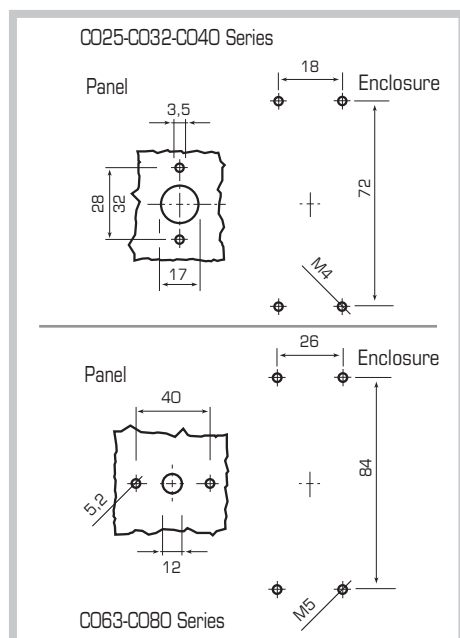

L x WAFERS No. WITH SHAFT EXTENSION 185 mm (ref. 20401089)

	L x WAFERS No. WITH SHAFT EXTENSION 185 mm (ref. 20401089)			
		1	2	3
min*	94,5	112	129,5	147
max	252,5	270	287,5	305
min*	129	155	181	207
max	277	303	329	355

Phoenix

Dimensions

Fixing details

BASE MOUNTING FOR DOOR INTERLOCK - PANEL MOUNTING B

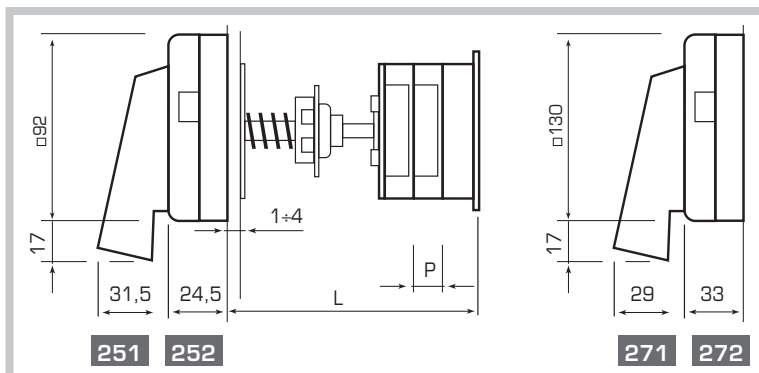

C100 SERIES

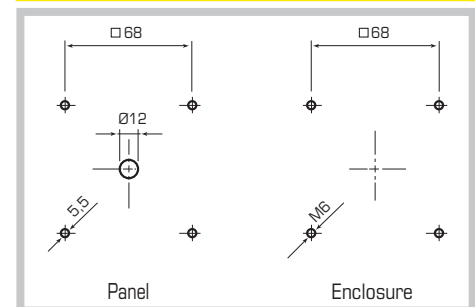

C200 SERIES

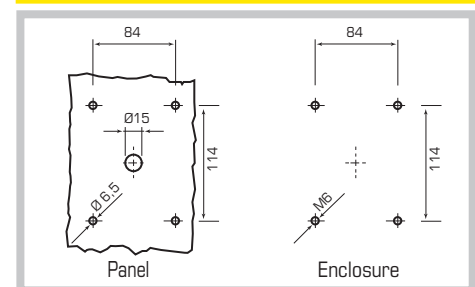

SERIES		L x WAFERS No. WITH SHAFT AS STANDARD				
		1	2	3	4	P
C100	min	134	162	190	218	28
	max	140	178	196	224	
C200	min	157	197	237	277	40
	max	163	203	243	283	

Length with long shaft = + 200 mm

C 100 Series shaft cod. 254

C 200 Series shaft cod. 274

BASE MOUNTING Ø 22,5 FOR DOOR INTERLOCK - PANEL MOUNTING B

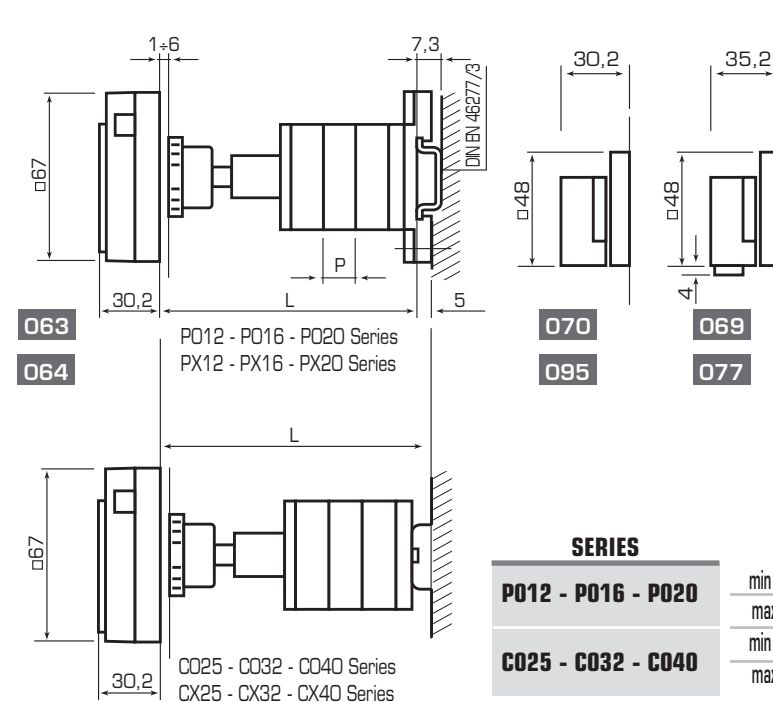

DRILLING TEMPLATE

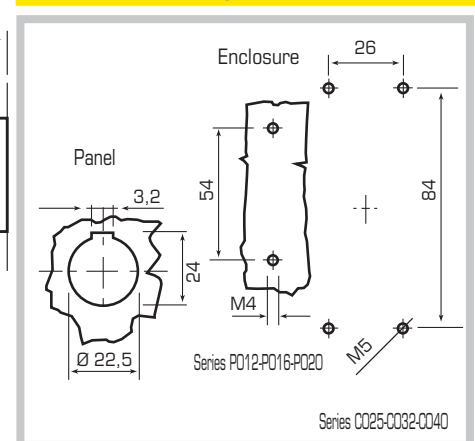

SERIES		L x WAFERS No. WITH SHAFT AS STANDARD				
		1	2	3	4	P
PO12 - PO16 - PO20	min*	79,5	92,2	104,9	117,6	12,7
	max	139	151,7	164,4	177,1	
CO25 - CO32 - CO40	min*	99,5	117	134,5	152	17,5
	max	159	176,5	194	211,5	

BASE MOUNTING - 46 mm - STANDARD ENCLOSURE

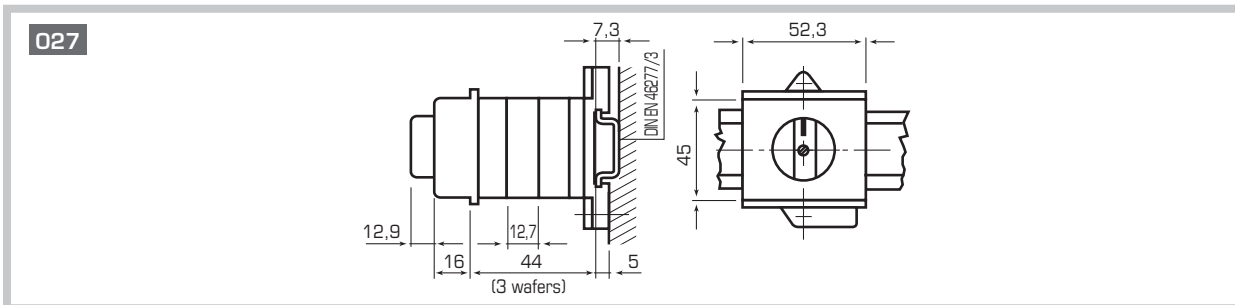

THERMOPLASTIC BOXES

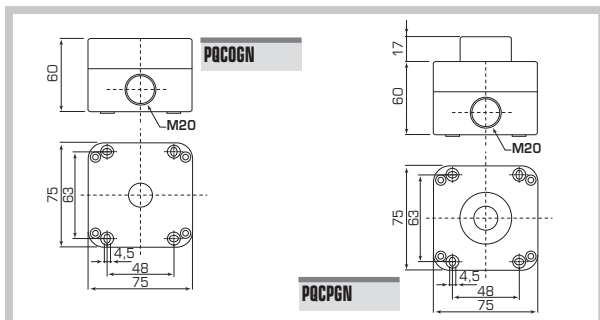
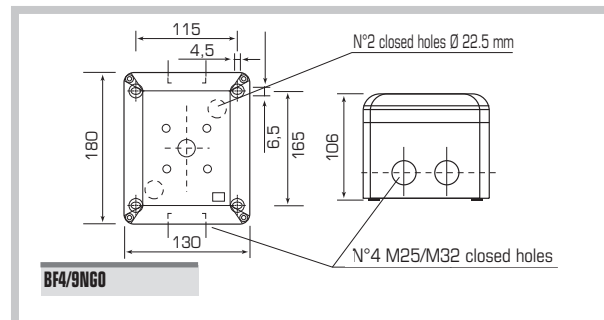
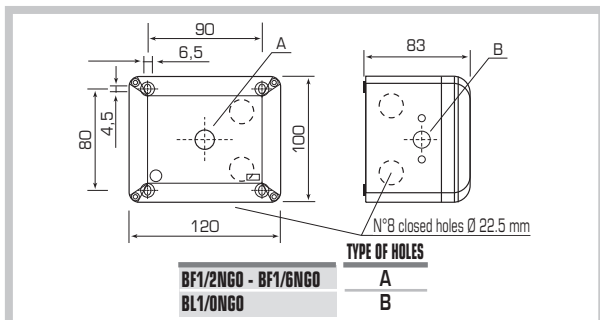

ALUMINIUM BOX

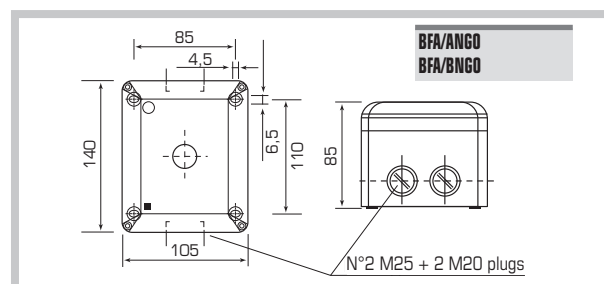

KNOBS AND LEVER

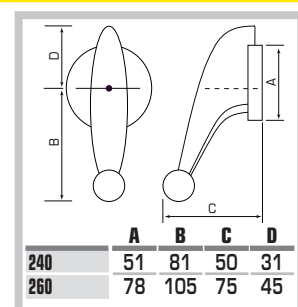
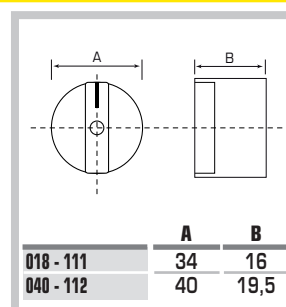
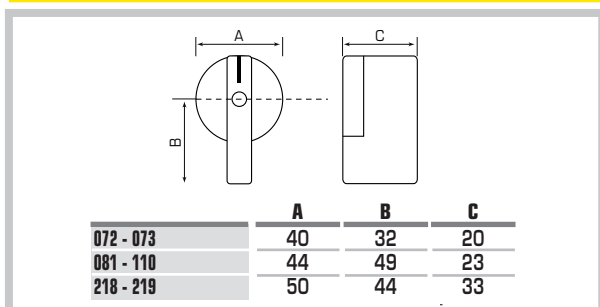

Phoenix

Cam switches

Special diagram on request

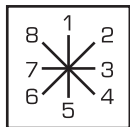

45 - 90

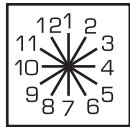

30 - 60

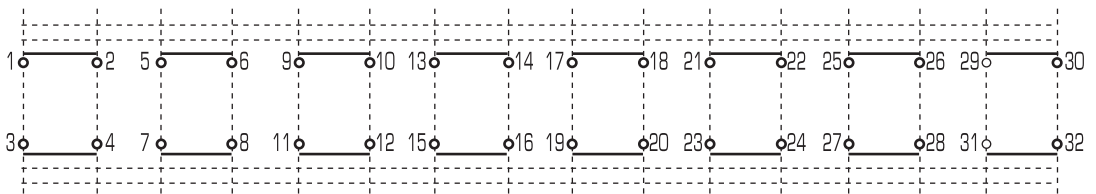

POS.	DESCRIPTION	POS.	DESCRIPTION
1		7	
2		8	
3		9	
4		10	
5		11	
6		12	

10	39-40		
	37-38		
9	35-36		
	33-34		
8	31-32		
	29-30		
7	27-28		
	25-26		
6	23-24		
	21-22		
5	19-20		
	17-18		
4	15-16		
	13-14		
3	11-12		
	9-10		
2	7-8		
	5-6		
1	3-4		
	1-2		
Wafer			
Contact			
			Position

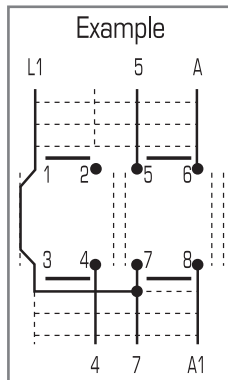

2	7-8		X
	5-6	X	X
1	3-4	X	X
	1-2		X
Wafer			
Contact		0	1
			M
			Position

- Open contact
- Closed contact
- Break before make
- Contact closed: no interruption during change-over
- Spring return
- Make before break
- Open contact early make

Rated current Ie		Operational rated voltage Ue	
Category	Amp/kw	Volt	
<input type="checkbox"/> AC-21A	A		V
<input type="checkbox"/> AC-22A	A		V
<input type="checkbox"/> AC-23A	1Ph	kW	V
	3Ph	kW	V
<input type="checkbox"/> AC-3	1Ph	kW	V
	3Ph	kW	V

Series _____

Mounting:

- Panel mounting
- Base mounting
- DIN rail

Operating:

Notes:

Company _____

Contact Mr _____

Ph. _____

Fax _____

E-mail _____

Quantity _____

Due date _____

Order No. _____

Regolus

Switch - disconnectors

Table of contents



AUTOMATION TECHNOLOGIES



Current rating from 25A up to 160A, panel, base and DIN rail mounting.
Available in the 2, 3 and 4-pole version with central control knob and through shaft.
2 and 3-pole fuse holders for switch-disconnectors up to 32A.

TABLE OF CONTENTS

■ Table of contents	pag.40	■ SE Series: Accessories	pag.57
■ SQ Series: Base mounting	pag.43	■ SQ Series: Characteristic	pag.58
Panel mounting and all complete products	pag.44	■ SE Series: Characteristic	pag.60
■ SE Series: Panel mounting and fuse holders	pag.48	■ SQ Series: Examples of mounting	pag.62
Complete products	pag.50	■ SE Series: Examples of mounting	pag.64
■ Plate for fixing with screws	pag.52	■ SQ Series: Dimensions	pag.65
■ Plate for central fixing \varnothing 22	pag.53	■ SE Series: Dimensions	pag.68
■ SQ Series: Accessories	pag.54	■ Enclosed installation dimensions	pag.70

Regolus

Switch - Disconnectors

Execution overview

SQ025 - SQ032 SERIES

PANEL MOUNTING



Type R - Fixing with screw

- Rated current from 25A to 40A
- Series modular with 3 extensible poles
- Shaft \square 6 mm - star shape
- Fixing panel spacing 28 mm horizontal with tapping screws
- Terminal protection class IP20
- Modular power and auxiliary contact

SQ025 - SQ032 SERIES

PANEL MOUNTING



Type S for central hole fixing \varnothing 22,5

- Rated current from 25A to 40A
- Series modular with 3 extensible poles
- Fixing panel on central hole \varnothing 22,5 mm
- Terminal protection class IP20
- Modular power and auxiliary contact

SQ025 - SQ032 SERIES

BOX - B



Type B for Door interlock

- Rated current from 25A to 40A
- Series modular with 3 extensible poles
- Fixing box on DIN rail - EN 50022-35 or with screws
- Terminal protection class IP20
- Modular power and auxiliary contact
- Type B: Standard
- Type K: Door Interlock with shaft mounting on the command

BOX - K



SQ025 - SQ032 SERIES

BOX - D



Type D - L1N direct command

- Rated current from 25A to 40A
- Series modular with 3 extensible poles
- Fix box on DIN - DIN-EN 50022-35 or with screw
- Complete with locking knob (1 lck)
- Terminal protection class IP20
- Modular power and auxiliary contact



Regolus

Switch - Disconnectors

Execution overview



AUTOMATION TECHNOLOGIES

SQ040 - SQ063 SERIES

PANEL MOUNTING

Type R - Fixing with screw

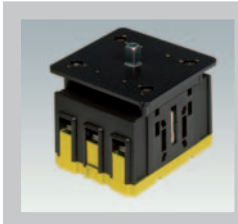

- Rated current from 63A to 80A
- Series modular with 3 extensible poles
- Independent manual operator - snap action
- Control Shaft □ 6 mm
- Fixing panel on distance □ 36 mm vertical - with screw self-tapping
- Terminal protection class IP20
- Modular power and auxiliary contact



SQ040 - SQ063 SERIES

BOX

Type B - Standard for door interlock

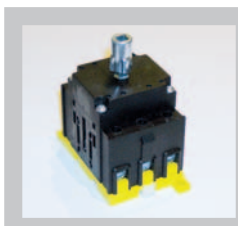

- Rated current from 63A to 80A
- Series modular with 3 extensible poles
- Independent manual operator - snap action
- Fix box on DIN - DIN-EN 50022-35 or with screw
- Terminal protection class IP20
- Modular power and auxiliary contact



SQ040 - SQ063 SERIES

BOX

Type D - L2N - direct command

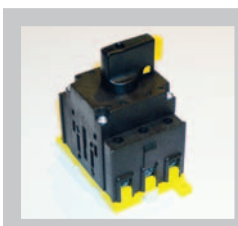

- Rated current from 63A to 80A
- Series modular with 3 extensible poles
- Independent manual operator - snap action
- Fix box on DIN - DIN-EN 50022-35 or with screw
- Complete of command to knob with locking (1 lck)
- Terminal protection class IP20
- Modular power and auxiliary contact



SQ125 - SQ160 SERIES

BOX

Type D - L2N Direct Command and Standard for door interlock



- Rated current from 125A to 160A
- Modular series with 3 extensible poles
- Central Shaft □ 5 mm
- Fix box on DIN - DIN-EN 50022-35 or with screw
- Complete of locked knob (1 lck) developed for door interlock command
- Modular power and auxiliary contact



Regolus

Switch - Disconnectors

Execution overview

SE16 - SE32 SERIES

PANEL MOUNTING - R



Type R - Fixing with screw - Type S - central fixing \varnothing 22,5

- Rated current from 32A to 40A
- Series with 4 poles
- Star shape control shaft \square 6 mm
- Terminal protection class IP20
- matching with auxiliares contacts
- **Type R:** Fixing panel on distant spacing 28 mm horizontal with
- **Type S:** Fixing panel on central hole \varnothing 22,5

PANEL MOUNTING - S



SE16 - SE32 SERIES

BOX



Type B for standard Door interlock

- Rated current from 32A to 40A
- Series with 4 poles
- Throghout metal shaft \square 5mm
- Fixing box on DIN RAIL EN 50022-35
- Terminal protection class IP20
- matching with auxiliares contacts

SE63 - SE100 SERIES

PANEL MOUNTING



Type R - Fixing with screw

- Rated current from 63A to 100A
- Series with 4 poles
- Throghout metal shaft \square 6mm
- Fixing panel on distant 36 mm with metric screws
- Terminal protection class IP20

SE63 - SE100 SERIES

BOX



Type B for standard Door interlock

- Rated current from 63A to 100A
- Series with 4 poles
- Throghout metal shaft \square 6 mm
- Fixing box DIN RAIL DIN-EN 50022-35 or with screws
- Terminal protection class IP20

Regolus

Switch - Disconnectors

SQ Series - Switch body



AUTOMATION TECHNOLOGIES

BASE MOUNTING



Base mounting

- Type B
- Fixing box DIN RAIL DIN-EN 50022-35
- Standard Enclosures for commands, door locking with shaft fixing details



Base mounting

- Type K
- Fixing box DIN RAIL DIN-EN 50022-35
- Standard Enclosures for commands, door locking with shaft fixing on the command

SERIES	AC-21A AMP. 690V	AC-23A AMP. 400V	DIAGRAMS		EXECUTION TYPE B		EXECUTION TYPE K	
	32	25	2 POLES	3 POLES	2 POLES	3 POLES	2 POLES	3 POLES
SQ025	32	25			SQ025002B	SQ025003B	SQ025002K	SQ025003K
SQ032	40	32			SQ032002B	SQ032003B	SQ032002K	SQ032003K

PANEL MOUNTING



Panel mounting

- Type R
- For screw fixing



Panel mounting

- Type R
- Fixing panel on central hole \varnothing 22.5

SERIES	AC-21A AMP. 690V	AC-23A AMP. 400V	DIAGRAMS		EXECUTION TYPE R		EXECUTION TYPE S	
	32	25	2 POLES	3 POLES	2 POLES	3 POLES	2 POLES	3 POLES
SQ025	32	25			SQ025002R	SQ025003R	SQ025002S	SQ025003S
SQ032	40	32			SQ032002R	SQ032003R	SQ032002S	SQ032003S



Base mounting

- Type B
- Fixing box DIN RAIL DIN-EN 50022-35
- Standard Enclosures for commands, door locking with shaft fixing details



Panel mounting

- Type R
- For screw fixing

SERIES	AC-21A AMP. 690V	AC-23A AMP. 400V	DIAGRAMS		6 POLES SWITCH		CHANGEOVER	
			6 POLES	3 POLES	BOX	PANEL MOUNTING	BOX	PANEL MOUNTING
SQ025	32	25			SQ025006B	SQ025006R	SQ025033B	SQ025033R
SQ032	40	32			SQ032006B	SQ032006R	SQ032033B	SQ032033R

Regolus

Switch - Disconnectors

SQ Series - Switch body - Complete devices

BASE MOUNTING

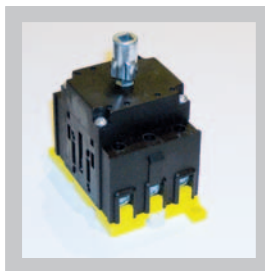

Box mounting

- Type B
- Din rail
DIN-EN 50022-35
- Standard Enclosures for door locking devices



SERIES	AC-21A AMP. 690V	AC-23A AMP. 400V	DIAGRAMS		EXECUTION TYPE B	
			2 POLES	3 POLES	2 POLES	3 POLES
SQ040	63	50			SQ040002B	SQ040003B
SQ063	80	67			SQ063002B	SQ063003B

PANEL MOUNTING FOR REAR FIXING

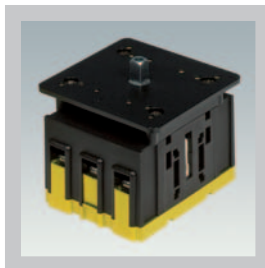

Panel mounting

- Type R
- Fixing with screws



SERIES	AC-21A AMP. 690V	AC-23A AMP. 400V	DIAGRAMS		EXECUTION TYPE R	
			2 POLES	3 POLES	2 POLES	3 POLES
SQ040	63	50			SQ040002R	SQ040003R
SQ063	80	67			SQ063002R	SQ063003R

BASE FIXING WITH DIRECT COMMAND - Complete devices



Direct command

- Type D - L1N
- Box fixing or DIN RAIL
DIN-EN 50022-35
- Black Knob locking
in O/OFF position

SQ025 - SQ032 Series

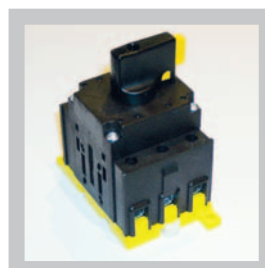

Direct command

- Type D - L2N
- Box fixing or Din rail
DIN-EN 50022-35
for 46 mm din panel
- Black Knob locking
in O/OFF position

SQ040 - SQ063 Series

SERIES	AC-21A AMP. 690V	AC-23A AMP. 400V	DIAGRAMS		EXECUTION TYPE D...	
			2 POLES	3 POLES	2 POLES	3 POLES
SQ025	32	25			SQ025002DL1N	SQ025003DL1N
SQ032	40	32			SQ032002DL1N	SQ032003DL1N
SQ040	63	50			SQ040002DL2N	SQ040003DL2N
SQ063	80	67			SQ063002DL2N	SQ063003DL2N

Regolus

Switch - Disconnectors

SQ125 - SQ160 Series



AUTOMATION TECHNOLOGIES

BASE FIXING WITH DIRECT COMMAND



Direct command

- Type D - L2N
- Box fixing or DIN RAIL
DIN-EN 50022-35
- Black Knob locking (1 lck) in O/OFF position



SQ125 - SQ160 Series

SERIES	AC-21A	AC-23A	DIAGRAMS		ENCLOSURE TYPE D - L2N	
	AMP. 690V	AMP. 400V	3 POLES	4 POLES	3 POLES	4 POLES
SQ125	125	125			SQ125003DL2N	SQ125004DL2N
SQ160	160	160			SQ160003DL2N	SQ160004DL2N

DOOR INTERLOCKS COMMAND



- 67
- Locking knob (max.3)
- Black front plate - black knob:
230/0001
- Yellow front plate - red knob:
231/0001

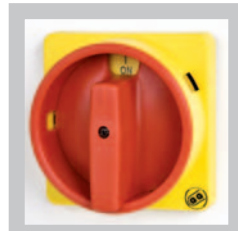

- 92
- Locking knob (max.3)
- Black front flange - black knob:
232/0001
- Yellow front flange - red knob:
233/0001

SQ125 - SQ160		230/0001	SQ125 - SQ160		232/001
		231/0001			233/001

ELECTRICAL CHARACTERISTIC

CHARACTERISTICS IEC/EN60947-3		SQ125	SQ160	Aux.
Rated insulation voltage U_i	V	800	800	250
Rated impulse withstand voltage U_{imp}	kV	8	8	-
Rated Thermal current 40° I _{th} -I _{the}	A	125	160 (200*)	12
RATED OPERATING CURRENT I_e: alternate current				
AC-21A Switching resistive loads with light overloads	690V A	125	160 (200*)	AC-15 415V - 3A
AC-22A Switching mixed resistive and inductive loads with light overloads	690V A	125	160	
AC-23A Periodic Switching of motors	3 phase - 3 pole			
	415V A/kW	125/55	160/75	
	500V A/kW	100/63	125/80	
	690V A/kW	80/75	100/90	
DC-23	48V A	125	160	-
2 pole serial connection	110V A	125	125	-
	220V A	100	100	-
Reated breaking capacity AC-23A (cosφ 0,35)	415V A	1000	1280	-
Conditional rated short circuit	kA	10,5	10,5	-
Fuse rating gG	A	125	125	-
Rated short-time short circuit withstand current I _{cw} (1s)	kA	3	3	-
Power dissipated for pole	W	2,5	3	-
Connectable section	mm ²	10÷70	10÷70	2,5
Mechanical life	Nr. of cycles	15.000	15.000	500.000

* with add terminals 95 mm

Regolus

Switch - Disconnectors

SQ Series - Complete devices

IP65 □ THERMOPLASTIC ENCLOSURES



C01 (120X100X85)

- Open cover in "O" position
- For n°8 cable gland Pg 16 + n°2 closed holes down
- Heat-resistant material
- Box in black - grey cover RAL 7035



E01 (130X180X106)

- Open cover in "O" position
- For n°4 cable gland M25/M32 + n°2 closed holes down ø 22,5
- Heat-resistant material
- Box in black - grey cover RAL 7035

SERIES	AC-21A AMP. 690V		AC-23A AMP. 400V		DIAGRAMS		C01		E01	
	32	40	25	32	3 POLES	6 POLES	3 POLES	3 POLES	6 POLES	
SQ025	32	40	25	32			SQ025003BC01	-	SQ025006BE01	
SQ032	40	40	32	32			SQ032003BC01	-	SQ032006BE01	
SQ040	63	63	50	50			-	SQ040003BE01	-	
SQ063	80	80	67	67			-	SQ063003BE01	-	

C09 - C10 (120X100X85)

- Open cover in "O" position
- For n°8 cable gland Pg 16 + n°2 closed holes down
- Heat-resistant material
- Locking in O/OFF (max 3 lock)
- Black front flange - Grey cover - Black knob: **C09**
- Yellow front flange - Red knob: **C10**

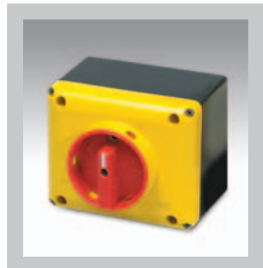
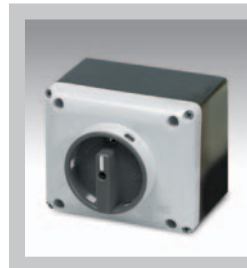

SERIES	AC-21A AMP. 690V		AC-23A AMP. 400V		DIAGRAMS		C09		C10	
	32	40	25	32	3 POLES	6 POLES	3 POLES	3 POLES	6 POLES	
SQ025	32	40	25	32			SQ025003BC09	-	SQ025003BC10	
SQ032	40	40	32	32			SQ032003BC09	-	SQ032003BC10	

E09 - E10 (130X180X106)

- Open cover in "O" position
- For n°4 cable gland M25/M32 + n°2 closed holes down ø 22,5
- Heat-resistant material
- Locking in O/OFF (max 3 lock)
- Black front flange - Black knob: **E09**
- Yellow front flange - Red knob: **E10**

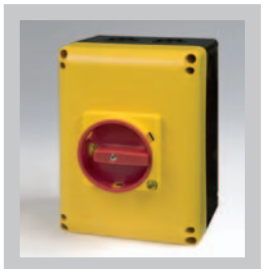

SERIES	AC-21A AMP. 690V		AC-23A AMP. 400V		DIAGRAMS		E09		E10	
	32	40	25	32	3 POLES	6 POLES	3 POLES	3 POLES	6 POLES	
SQ025	32	40	25	32			-	SQ025006BE09	-	SQ025006BE10
SQ032	40	40	32	32			-	SQ032006BE09	-	SQ032006BE10
SQ040	63	63	50	50			SQ040003BE09	-	SQ040003BE10	-
SQ063	80	80	67	67			SQ063003BE09	-	SQ063003BE10	-

Regolus

Switch - Disconnectors

SQ Series - Complete devices



AUTOMATION TECHNOLOGIES

IP65 - METAL - BOX ENCLOSURES

A09 - A10 (105X140X85)

- Open cover in "O" position
- For n°4 cable glands M25/M32 + n°2 hole plugs M20 and M25
- Material Zn - Al
- Locking in O/OFF (max 3 lock)
- Black Box - Grey front flange - Black knob: **A09**
- Black Box - Yellow front flange - Red knob: **A10**



SERIES	DIAGRAMS		A09	A10
	AC-21A AMP. 690V	AC-23A AMP. 400V	3 POLES	3 POLES
SQ025	32	25	SQ025003DA09	SQ025003DA10
SQ032	40	32	SQ032003DA09	SQ032003DA10

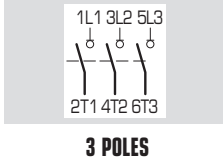

AB9 - ABO (150X200X110)

- Open cover in "O" position
- N°2 hole plugs M40
- Material Zn - Al
- Locking in O/OFF (max 3 lock)
- Black Box - Grey front flange - Black knob: **AB9**
- Black Box - Yellow front flange - Red knob: **ABO**



SERIES	DIAGRAMS		AB9		ABO	
	AC-21A AMP. 690V	AC-23A AMP. 400V	3 POLES	4 POLES	3 POLES	4 POLES
SQ040	63	50	SQ040003DAB9	SQ040004DAB9	SQ040003DAB0	SQ040004DAB0
SQ063	80	63	SQ063003DAB9	SQ063004DAB9	SQ063003DAB0	SQ063004DAB0

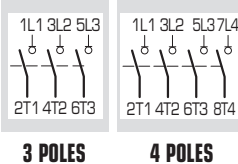

Regolus

Switch - Disconnectors

SE Series - Switch body

BASE FIXING



Base fixing

Type B

Base fixing or Din rail
DIN-EN 50022-35

Door locking execution

SE16 - SE32



Base fixing

Type B

Base fixing or Din rail
DIN-EN 50022-35 or with screws

Door locking execution

SE63 - SE80 - SE100

DIAGRAMS

SERIES	AC-21A AMP. 690V	AC-23A AMP. 400V		EXECUTION TYPE B				
				2 POLES	3 POLES	4 POLES		
SE16	32	25				SE1610F2B	SE163003B	SE163004B
SE32	40	32				SE3210F2B	SE323003B	SE323004B
SE63	63	50				SE630002B	SE630003B	SE630004B
SE80	80	60				SE800002B	SE800003B	SE800004B
SE100	100	67				SE1000002B	SE1000003B	SE1000004B

PANEL MOUNTING



Panel mounting

Type R

Fixing with screws

SE16 - SE32



Panel mounting

Type R

Fixing with screws

SE63 - SE80 - SE100

DIAGRAMS

SERIES	AC-21A AMP. 690V	AC-23A AMP. 400V		EXECUTION TYPE R				
				2 POLES	3 POLES	4 POLES		
SE16	32	25				SE1610F2R	SE163003R	SE163004R
SE32	40	32				SE3210F2R	SE323003R	SE323004R
SE63	63	50				SE630002R	SE630003R	SE630004R
SE80	80	60				SE800002R	SE800003R	SE800004R
SE100	100	67				SE1000002R	SE1000003R	SE1000004R



Panel mounting

Type S

Central fixing hole \varnothing 22.5

SE16 - SE32

DIAGRAMS

SERIES	AC-21A AMP. 690V	AC-23A AMP. 400V		EXECUTION TYPE S				
				2 POLES	3 POLES	4 POLES		
SE16	32	25				SE1610F2S	SE163003S	SE163004S
SE32	40	32				SE3210F2S	SE323003S	SE323004S

Regolus

Switches - Disconnectors with fuses holders

SE Series - Panel mounting bases



AUTOMATION TECHNOLOGIES

PANEL MOUNTING BASES FOR ENCLOSURES



DISCONNECTOR WITH FUSE-HOLDERS

Type B box
DIN EN 50022-35
rail mounting for door
interlocks knobs
Sectionable fuses holders
For cylindrical fuses
10.3x3 8mm UL

FS20 - FS30



SECTIONABLE FUSES HOLDER

For disconnectors series
SE16-SE32 2-3-4 poles type B box
For cylindrical fuses 10.3x38
mm max. 32A
IP20 terminals protection

TF322 - TF323

DISCONNECTOR WITH FUSE-HOLDERS

FUSE-HOLDERS

SERIES	AC-21A AMP. 690V	UL GENERAL USE AMP./600V	2 POLES		3 POLES		4 POLES		2 POLES		3 POLES	
			Diagram	Diagram	Diagram	Diagram	Diagram	Diagram	Diagram	Diagram		
FS20	25	20	FS2010F2B	FS203003B	FS203004B	TF322	TF323					
FS30	32	30	FS3010F2B	FS303003B	FS303004B							

OVERALL DIMENSIONS

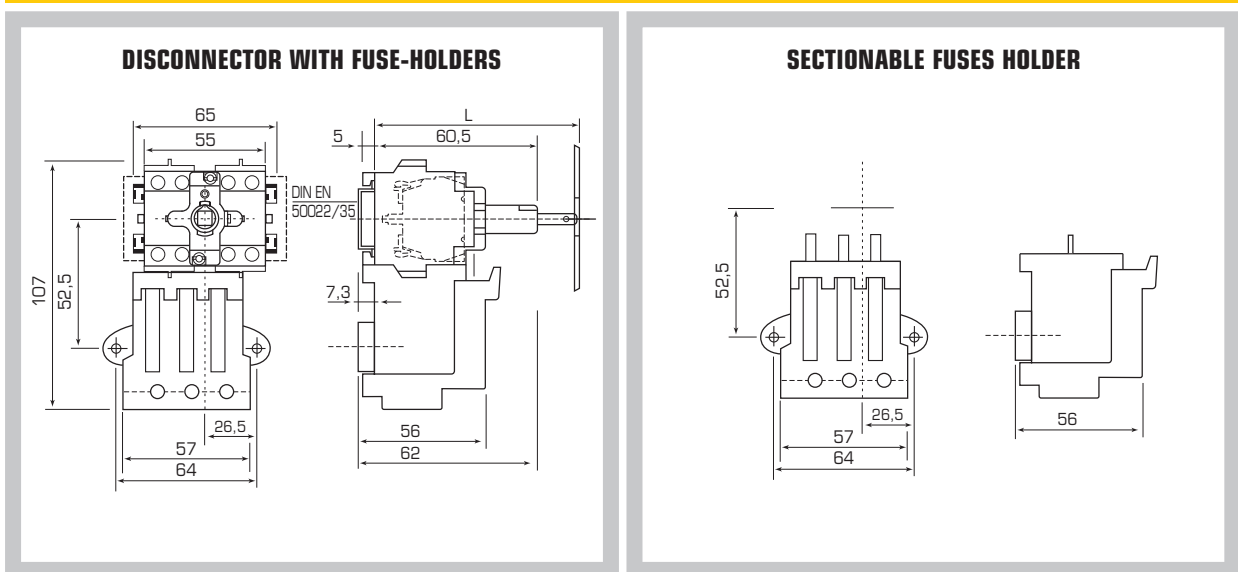

MOUNTING DEPTH

	WITH STANDARD SHAFT	WITH SHAFT EXECUTION 20401089
L min.	80	80
L max.	120	220

Regolus

Switches - Disconnectors

SE Series - Complete devices

IP65 □ THERMOPLASTIC ENCLOSURES



C01 (120X100X85)

- Opening in "O" position
- Nr. 8 Pg16 knock-outs of which nr. 2 on the bottom
- Heat-resistant material
- Black box - Grey cover
RAL 7035



E01 (130X180X106)

- Opening in "O" position
- Nr. 4 knock-outs M25/M32 + nr. 2 ø 22 mm closed hole on the bottom
- Heat-resistant material
- Black box - Grey cover
RAL 7035

SERIES	AC-21A AMP. 690V	AC-23A AMP. 400V	DIAGRAMS		C01		E01	
			3 POLES	4 POLES	3 POLES	4 POLES		
SE16	32	25			SE160003BC01	SE160004BC01	-	-
SE32	40	32			SE320003BC01	SE320004BC01	-	-
SE63	63	50			-	-	SE630003BE01	SE630004BE01
SE80	80	60			-	-	SE800003BE01	SE800004BE01

C09 - C10 (120X100X85)

- Opening in "O" position
- Nr. 8 Pg16 cable glands of which nr. 2 on the bottom
- Heat-resistant material
- With locking facility in O/OFF (max 3 padlocks)
- Black box - Grey cover - Black knob: **C09**
- Black box - Yellow cover - Red knob: **C10**

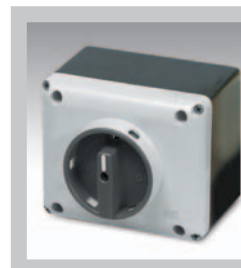

SERIES	AC-21A AMP. 690V	AC-23A AMP. 400V	DIAGRAMS		C09		C10		
			3 POLES	4 POLES	3 POLES	4 POLES			
SE16	32	25			SE160003BC09	SE160004BC09	SE160003BC10	SE160004BC10	
SE32	40	32			SE320003BC09	SE320004BC09	SE320003BC10	SE320004BC10	

E09 - E10 (130X180X106)

- Opening in "O" position
- Nr. 4 M25/M32 cable glands + nr. 2 ø 22 mm closed hole on the bottom
- Heat-resistant material
- With locking facility in O/OFF (max 3 padlocks)
- Black box - Grey cover - Black knob: **E09**
- Black box - Yellow cover - Red knob: **E10**



SERIES	AC-21A AMP. 690V	AC-23A AMP. 400V	DIAGRAMS		E09		E10		
			3 POLES	4 POLES	3 POLES	4 POLES			
SE63	63	50			SE630003BE09	SE630004BE09	SE630003BE10	SE630004BE10	
SE80	80	60			SE800003BE09	SE800004BE09	SE800003BE10	SE800004BE10	

Regolus

Switches - Disconnectors

SE Series - Complete devices



AUTOMATION TECHNOLOGIES

IP65 □ THERMOPLASTIC ENCLOSURES

C41 - C42 (140X230X114)

- Opening in "O" position
- Complete with nr.2 M32 and nr. 2 M40 hole plugs
- Heat-resistant material
- With locking facility in O/OFF (max 3 padlocks)
- Black box - Yellow cover - Red knob: **C41**
- Black box - Grey cover - Black knob: **C42**



SERIES	AC-21A	AC-23A	DIAGRAMS		C41		C42	
	AMP. 690V	AMP. 400V	3 POLES	4 POLES	3 POLES	4 POLES	3 POLES	4 POLES
SE100	100	67			SE1000003BC41	SE1000004BC41	SE1000003BC42	SE1000004BC42

IP65 METAL ENCLOSURES

A09 - A10 (105X140X85)

- Opening in "O" position
- Complete with nr. 2 M20 and nr. 2 M25 hole plugs
- Zn - Al material
- With locking facility in O/OFF (max 3 padlocks)
- Black box - Grey cover - Black knob: **A09**
- Black box - Yellow cover - Red knob: **A10**



SERIES	AC-21A	AC-23A	DIAGRAMS		A09		A10	
	AMP. 690V	AMP. 400V	3 POLES	4 POLES	3 POLES	4 POLES	3 POLES	4 POLES
SE16	32	25			SE160003BA09	SE160004BA09	SE160003BA10	SE160004BA10
SE32	40	32			SE320003BA09	SE320004BA09	SE320003BA10	SE320004BA10

AB9 - ABO (150X200X110)

- Opening in "O" position
- Complete with nr.2 M40 hole plugs
- Zn - Al material
- With locking facility in O/OFF (max 3 padlocks)
- Black box - Grey cover - Black knob: **AB9**
- Black box - Yellow cover - Red knob: **ABO**









SERIES	AC-21A	AC-23A	DIAGRAMS		AB9		ABO	
	AMP. 690V	AMP. 400V	3 POLES	4 POLES	3 POLES	4 POLES	3 POLES	4 POLES
SE63	63	50			SE630003BA09	SE630004BA09	SE630003BABO	SE630004BABO
SE80	80	60			SE800003BA09	SE800004BA09	SE800003BABO	SE800004BABO
SE100	100	67			SE1000003BA09	SE1000004BA09	SE1000003BABO	SE1000004BABO

Regolus

Plates - screw fixing

Panel mounting bases Type R - door interlock for Type B and K bases

EN60529 IP65 - UL50 Type 1 - 4 - 4x (*) NEMA 4X PROTECTION

	DESCRIPTION	FOR SERIES	PANEL MOUNTING	DOOR INTERLOCK	
			FOR TYPE R BASES	FOR TYPE B BASES	FOR TYPE K BASES
	Grey plate Black knob	SQ025 - SQ032 SE16 - SE32	001/0001	020/0001	-
□48					-
	Grey plate Black knob With locking facility	SQ025 - SQ032 SE16 - SE32	♦003/0001	♦005/0001	-
□48					-
	Grey plate Black knob With locking facility (Max3)	SQ025 - SQ032 SE16 - SE32 SQ040 - SQ063 SE63.....SE100	♦009/0001 ♦049/0001	♦011/0001 ♦041/0001	- 091/0001 - -
□67					
	Yellow plate Red knob	SQ025 - SQ032 SE16 - SE32	002/0001	030/0001	-
□48					-
	Yellow plate Red knob With locking facility	SQ025 - SQ032 SE16 - SE32	♦004/0001	♦006/0001	-
□48					-
	Yellow plate Red knob With locking facility (Max3)	SQ025 - SQ032 SE16 - SE32 SQ040 - SQ063 SE63.....SE100	♦010/0001 ♦050/0001	♦012/0001 ♦042/0001	- - - -
□67					

♦ See p/n devices

Regolus







Plates - ø 22 hole central fixing

Panel mounting bases S Type - door interlock for B Type



AUTOMATION TECHNOLOGIES

EN60529 IP65 - UL50 Type 1 - 4 - 4x (*) NEMA 4X PROTECTION

	DESCRIPTION	FOR SERIES	PANEL MOUNTING	DOOR INTERLOCK
			FOR TYPE S BASES	FOR TYPE B BASES
	Grey plate Black knob □48	SQ025 - SQ032	079/0001	095/0001
		SE16 - SE32	079/0001	
	Grey plate Black knob With locking facility □48	SQ025 - SQ032	♦ 087/0001	♦ 077/0001
		SE16 - SE32	♦ 087/00E1	
	Grey plate Black knob With locking facility (Max3) □67	SQ025 - SQ032	♦ 089/0001	♦ 063/0001
		SE16 - SE32	♦ 089/00E1	
		SQ040 - SQ063	-	♦ 065/0001
		SE63.....SE100	-	
	Yellow plate Red knob □48	SQ025 - SQ032	080/0001	070/0001
		SE16 - SE32	080/0001	
	Yellow plate Red knob With locking facility □48	SQ025 - SQ032	♦ 088/0001	♦ 069/0001
		SE16 - SE32	♦ 088/00E1	
	Yellow plate Red knob With locking facility (Max3) □67	SQ025 - SQ032	♦ 090/0001	♦ 064/0001
		SE16 - SE32	♦ 090/00E1	
		SQ040 - SQ063	-	♦ 066/0001
		SE63.....SE100	-	

♦ See p/n devices

Regolus

Switch - Disconnectors

SQ025 - SQ032 Series - Accessories

IP65 - THERMOPLASTIC BOX



For SQ025 - SQ032 Series
For Panel mounting basis type "R"
Black Box - Grey Cover
RAL 7035
Dimensions: 120X100X85 mm
For nr. 8 M20 cable glands
M20



SQ025 - SQ032 Series **4 Poles Max.** **BF3/FNGO**

IP65 - THERMOPLASTIC BOX

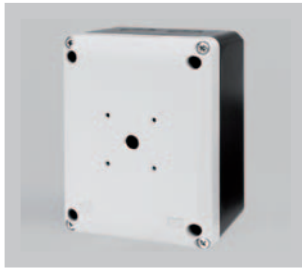

For SQ025-SQ032 Series
For Bodies-Panel mounting type "R"
Black Box - Grey Cover
RAL 7035
Dimensions: 130X180X106 mm
For n°4 cable glands
M25/M32



SQ025 - SQ032 Series **6 Poles Max.** **BF4/DNGO**

IP65 - METAL BOX - CLOSED

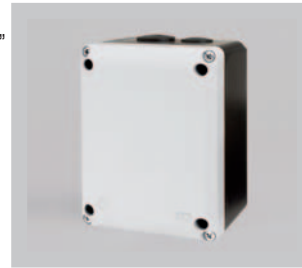

For SQ025-SQ032 Series
For Bodies-Panel mounting type
"B" and "R"
Black Box - Grey Cover
RAL 7035
Dimensions: 105X140X85 mm
For n°2 M20 and
n°2 M25 cable glands



SQ025 - SQ032 Series **4 Poles Max.** **BFA/ONGA**

ADDITIONAL POLES



SERIES	DIAGRAM	CODE - BOX	CODE - PANEL MOUNTING
SQ025		SQ025AFPB	SQ025AFPR
		SQ032AFPB	SQ032AFPR
SQ032		SQ025ANIB	SQ025ANIR
		SQ032ANIB	SQ032ANIR
		SQ025ANPB	SQ025ANPR
		SQ032ANPB	SQ032ANPR
		SQ025APEB	SQ025APER
		SQ032APEB	SQ032APER

AUXILIARY CONTACTS



SERIES	DIAGRAM	CODE - BOX	CODE - PANEL MOUNTING
SQ025		SQ010AS1B	SQ010AS1R
			SQ010AS2B

TERMINAL PROTECTION



BOX	PANEL MOUNTING	BOX AND PANEL MOUNTING
20900023	20900024	20900025

SHAFT EXTENSION 5 DOOR INTERLOCK BASIS TYPE B

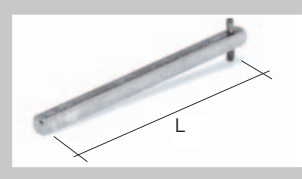

FOR INTERLOCK BASIS TYPE B	
L 185 mm	20401089
L 300 mm	20401164

FIXING KEY



PCF

Regolus

Switch - Disconnectors

SQ040 - SQ063 Series - Accessories



AUTOMATION TECHNOLOGIES

IP65 - THERMOPLASTIC BOX

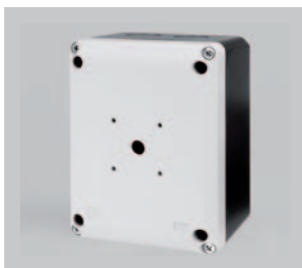

For SQ040 - SQ063 Series
For Panel mounting basis type "R"
Black Box - Grey Cover
RAL 7035
Dimensions: 130x180x106 mm.
For nr. 4 M25/M32 cable glands



SQ040 - SQ063 Series **4 Poles Max.** BFA/DNGO

IP 65 - METAL BOX - CLOSED

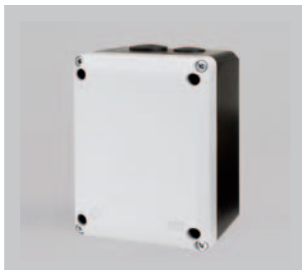

For SQ040 - SQ063 Series
For Bodies-Panel mounting type "R"
Black Box - Grey Cover
RAL 7035
Dimensions: 105x140x85 mm.
Complete with nr. 2 M40 cable glands



SQ040 - SQ063 Series **3 Poles Max.** BNA/ONGA

IP 65 - METAL BOX - CLOSED

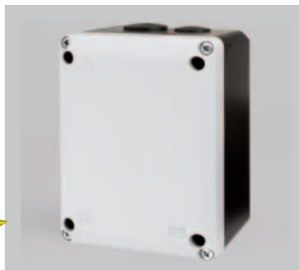

For SQ040 - SQ063 Series
For Bodies-Panel mounting type "B" and "R"
Black Box - Grey Cover
RAL 7035
Dimensions: 150x200x110 mm.
Complete with nr. 2 cable glands M40



SQ040 - SQ063 Series **4 Poles Max.** BNA/ENGA

ADDITIONAL POLES



Box



Panel mounting

SERIES	DIAGRAM	CODE - BOX	CODE - PANEL MOUNTING
SQ040		SQ040AFPB	SQ040AFPR
		SQ040ANIB	SQ040ANIR
SQ063		SQ063ANIB	SQ063ANIR
		SQ040ANPB	SQ040ANPR
		SQ063ANPB	SQ063ANPR
		SQ040APEB	SQ040APER
		SQ063APEB	SQ063APER



AUXILIARY CONTACTS



Box



Panel mounting

SERIES	DIAGRAM	CODE - BOX	CODE - PANEL MOUNTING
SQ040		SQ010AS3B	SQ010AS3R
SQ063		SQ010AS4B	SQ010AS4R

TERMINAL PROTECTION



SQ040 - SQ063 SERIES
3 POLES



SQ040 - SQ063 SERIES
1 POLE

BOX AND PANEL MOUNTING
20900041

BOX AND PANEL MOUNTING
20900040

SHAFT EXTENSION 6 FOR DOOR INTELLOCK

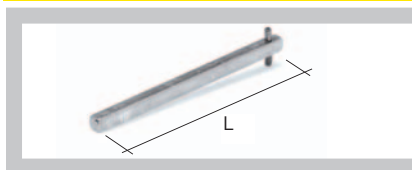

SQ040 - SQ063 SERIES

L 185 mm	20900010
L 300 mm	20900011



Regolus

Switch - Disconnectors

SQ125 - SQ160 Series - Accessories

ADDITIONAL POLES



SERIES	DIAGRAM	CODE
SQ125	7 — 8	SQ160AFPB
SQ160	N — N	SQ160ANPB
	PE — PE	SQ160APEB



AUXILIARIES CONTACTS



SERIES	DIAGRAM	CODE
SQ125	1 — 2	SQ003AS5B
SQ160	1 — 4	

COVER-CLAMP



3 POLES

20900034



1 POLE

20900035



SHAFT EXTENTION 6 FOR DOOR INTELOCK

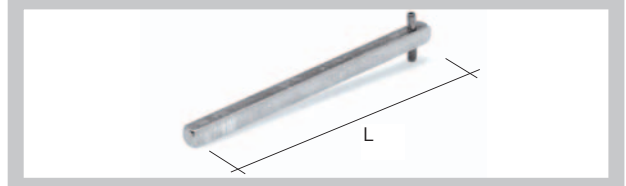

SQ040 - SQ063 SERIES

L 185 mm

20900010

L 300 mm

20900011

CLAMP 95 mm²



20900036



Regolus

Switch - Disconnectors

SE16 - SE100 Series - Accessories



AUTOMATION TECHNOLOGIES

IP65 - THERMOPLASTIC BOX



For SE16 - SE32 Series
For Panel mounting basis type "B"
Black Box - Grey Cover
RAL 7035
Dimensions: 120X100X85 mm
For nr. 8 M20 cable glands
Order also:
Shaft 11706237
Plate support 11814005

SE16 - SE32...B SERIES
BF1/1NGO



For SE16 - SE32 Series
For Panel mounting basis type "R"
Black Box - Grey Cover
RAL 7035
Dimensions: 120X100X85 mm
For nr. 8 M20 cable glands

SE16 - SE32...R SERIES
BF1/2NGO

IP65 - THERMOPLASTIC BOX - CLOSED



For SE16 - SE32 Series
For Panel mounting basis type "R"
Black Box - Grey Cover
RAL 7035
Dimensions: 120X100X85 mm
For nr. 8 M20 cable glands

SE16 - SE32...R SERIES
BN1/ONGO

IP65 - ALUMINIUM BOX - CLOSED

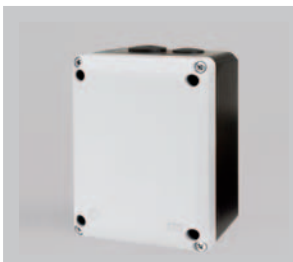

For SE16 - SE32 Series
For Panel mounting basis type B and R
Black Box - Grey Cover
RAL 7035
Dimensions: 105X140X85 mm
Complete with nr. 2 M20 and M25 cable glands taps

SE16 - SE32 SERIES
BNA/ONGA

BOX FIXING PLATE



SE16-SE32 SERIES
11814005

SHAFT EXTENTION FOR BOX EXECUTION

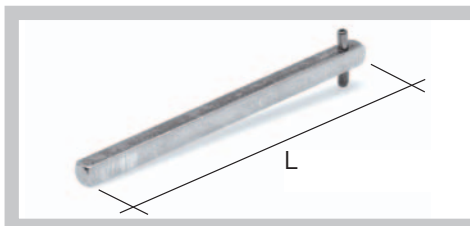

	SE16-SE32	SE63...SE100
L 185 mm	20401089	20900010
L 300 mm	20401164	20900011

BOX SHAFT BF1/1NGO



SE16-SE32 SERIES
11706237

AUXILIARIES CONTACTS



SE16 - SE32 SERIES
1 NC PLO04001
1 NO PLO04002

AUXILIARY CONTACT FIXING PLATE



SE16 - SE32 SERIES
11814021

COVER-CLAMP



SE63...SE100 SERIES
4 POLES BOX AND PANEL MOUNTING
20900003

Regolus

Switch - Disconnectors - SQ Series

Electrical characteristics

EN 60947-3 CHARACTERISTICS			SQ025	SQ032	SQ040	SQ063	AUXILIARIES CONTACTS
Rated operating voltage U _e	V		690	690	690	690	690
Rated insulation voltage U _i	V		690	690	690	690	690
Rated impulse withstand voltage U _{imp} (sectionable)	kV		8	8	8	8	4
Rated thermal current I _{th}	A		32	40	63	80	16
Rated thermal current in enclosed I _{the}	A		32	40	63	80	10
Frequency	Hz		50/60	50/60	50/60	50/60	50/60
RATED OPERATING CURRENT I_e: alternate current							
AC-21A Switching resistive loads with light overloads	690V	A	32	40	63	80	AC-15 240V - 5A
AC-22A Switching mixed resistive and inductive loads at light overloads	500V	A	-	-	-	-	DC-13 250V-0,44A
	690V	A	25	32	63	80	
AC-23A Periodic switching of motors 3 phase - 3 poles	230V	A/kW	25/7,5	32/10	50	75	-
	400V	A/kW	25/15	32/18,5	50	67	-
	500V	A/kW	25/15	32/22	45	67	-
	690V	A/kW	16/15	20/18,5	26	32	-
AC3 Starting of cage motors (interruption while running) 3 phase - 3 poles	230V	A/kW	22/5,5	27/7,5	45	60	-
	400V	A/kW	22/11	27/15	40	55	-
	500V	A/kW	22/11	27/18,5	35	45	-
	690V	A/kW	16/11	20/15	22	25	-
Nominal interruption power AC-23A (cosφ 0,45)	230V	A	200	256	360	600	-
	400V	A	200	256	320	536	-
	500V	A	200	256	280	536	-
	690V	A	128	160	176	256	-
SHORT CIRCUIT CHARACTERISTICS							
Rated short-time short circuit withstand current I _{cw} (1s)	A		800	800	1200	1500	-
Rated short circuit making capacity I _{cm}	A		1500	1500	2200	2800	-
Conditional rated short circuit withstand current	kA		10	10	10 5	10 5	1
Fuse rating gG	500V	A	-	-	-	-	10
	690V	A	40	40	63 80	63 80	-
UL 508 CHARACTERISTICS							
General use	600V ac	A	32	40	60	80	HD A600 ac G600 dc
Standard motors load	Single phase - 2 poles	120V ac HP(FLA)	1,5 (20)	2 (24)	-	-	-
		200: 208V ac HP	2	3	-	-	-
		240V ac HP(FLA)	3 (17)	5 (28)	-	-	-
		200: 208V ac HP	7,5	10	15	20	-
	3 phase - 3 poles	240V ac HP(FLA)	7,5 (22)	10 (28)	15	20	-
		480V ac HP(FLA)	10 (14)	15 (21)	30	40	-
		600V ac HP(FLA)	15 (17)	20 (22)	30	40	-

Regolus

Switch - Disconnectors - SQ Series

General characteristics



AUTOMATION TECHNOLOGIES

	IEC/EN60947-3 - UL508		IEC/EN60947-5-1 - UL508			
	SQ032 - SQ040		AUXILIARIES CONTACTS			
Comply with rules						
Protection class	control	EN60529 (UL 50♦)	IP65 (Type 1 - 4 - 4X - NEMA 4X)			
	terminals	EN60529	IP20			
Material group	EN60947-1		II			
Pollution grade	EN60947-1		3			
Flammability	UL94		VO: powered parts			
Ambient temperature	°C		Operating : -25 +55			
	°C		Storage : -30 +70			
Climate withstand	IEC68 part 2-3		Hot damp			
	IEC68 part 2-30		Unsettled hot damp			
Switching force (3 poles)			0,8 Nm (7,1 lb.in.)	1 Nm (8,85 lb.in.)		
Connections:						
Terminal block caliber	EN60947-1		A6	A8		
Terminal screw			M4	M5		
Screwing torque	EN60947-1		1,2 Nm	3 Nm		
	UL 508		10,6 lb.in. (1,2 Nm)	32,0 lb.in. (3,6 Nm)		
Connectable section:						
Flexible conductors	n°. 1 min/max	mm²	1,5-10	6-25		
		AWG	12-6	10-2		
Solid conductors	n°. 1 min/max	mm²	1,5-16	10-35		
		AWG	12-6	10-2		
Contacts			Slow opening double-break positive opening	Slow opening double-break positive opening		
Opening angles			90°			
Mechanical lifetime at 120 operations per hour mil/cl	nr. of cycles		100.000	10.000		
CERTIFICATIONS						
	CE mark - Europa					
	cUL Listed - Usa and Canada					
	IMQ Istituto Marchio Qualità - Italia					
	CCC Cina					
	GOST Russia					
♦ See p/n devices						
		SQ025	SQ032	SQ040	SQ063	AUXILIARIES CONTACTS
		-	-	-	-	
		-	-	-	-	

Regolus

Switch - Disconnectors - SE Series

Electrical characteristics

EN 60947-3 CHARACTERISTICS

		SE16	SE32	SE63	SE80	SE100
Rated operating voltage U _e	V	690*	690*	690	690	690
Rated insulation voltage U _i	V	690*	690*	690	690	690
Rated impulse withstand voltage U _{imp} (sectionable)	kV	4*	4*	8	8	8
Rated thermal current I _{th}	A	(30*) 32	40*	63*	86*	100
Rated thermal current in enclosed I _{the}	A	(30*) 32	40*	63*	86*	86
Frequency	Hz	50	50	50	50	50

RATED OPERATING CURRENT I_e: alternate current

AC-21A Switching resistive loads with light overloads	690V	A	(30*) 32	(32*) 40	63*	80*	100
AC-22A Switching mixed resistive and inductive loads at light overloads	500V	A	-	-	-	-	100
	690V	A	(20*) 25	32*	63*	80*	86
AC-23A Periodic switching of motors 3 phase - 3 poles	230V	A/kW	25/7.5	32/10	50/15	63/18,5	70/22
	400V	A/kW	25/15	32/18,5	50/30	60/33	67/37
	500V	A/kW	25/15	32/22	50/37	60/40	67/45
	690V	A/kW	(16A*) 20/18,5	25*/22	32/30	35/33	38/37
AC3 Starting of cage motors (interruption while running) 3 phase - 3 poles	230V	A/kW	22/7.5	30/9	40/11	50/15	60/18,5
	400V	A/kW	22/11	30/15	40/22	50/25	55/30
	500V	A/kW	22/11	30/18,5	40/30	50/33	55/37
	690V	A/kW	(12A*) 22/11	(20A*) 22/18,5	25/22	27/25	32/30
Nominal interruption power AC-23A (cosφ 0,45)	230V	A	200	256	400	504	560
	400V	A	200	256	400	480	536
	500V	A	200	256	400	480	536
	690V	A	160	200	256	280	304

SHORT CIRCUIT CHARACTERISTICS

Rated short-time short circuit withstand current I _{cw} (1s)	A	400*	400*	1500	1500	1500
Rated short circuit making capacity I _{cm}	A	1500*	1500*	2840	2840	2840
Conditional rated short circuit withstand current	kA	10*	10*	10*	10*	10
Fuse rating gG	500V	A	-	-	-	100
	690V	A	40*	40*	(80*) 63	80*

UL 508 CHARACTERISTICS

General use	600V ac	A	32	40	63	80	100
Standard motors load	Single phase - 2 poles	120V ac HP(FLA)	1,5 (20)	2 (24)	3 (34)	3(34)	3 (34)
		240V ac HP(FLA)	3 (17)	5 (28)	7,5 (40)	7,5 (40)	10 (50)
	3 phase - 3 poles	240V ac HP(FLA)	7,5 (22)	10 (28)	10 (28)	10 (28)	10 (28)
		480V ac HP(FLA)	10 (14)	15 (21)	20 (27)	25 (34)	25 (34)
		600V ac HP(FLA)	15 (17)	20 (22)	25 (27)	30 (32)	30 (32)

* IMQ values

Regolus

Switch - Disconnectors - SE Series

General characteristics



AUTOMATION TECHNOLOGIES

			IEC947-3, EN60947-3, UL508																																								
			SE16 - SE32		SE63 - SE80 - SE100																																						
■ Comply with rules	Protection class	control	EN60529 (UL 50♦)																																								
		terminals	EN60529																																								
■	Material group	EN60947-1																																									
■	Pollution grade	EN60947-1																																									
■	Flammability	UL94																																									
■	Ambient temperature		°C																																								
			°C																																								
■	Climate withstand		IEC68 part 2-3																																								
			IEC68 part 2-30																																								
■	Switching force (3 poles)	0,6 Nm (5,3 lb.in.)		1,5 Nm (13,3 lb.in.)																																							
■	Connections:																																										
	Terminal block caliber	EN60947-1																																									
	Terminal screw	A6		A8																																							
	Screwing torque	M4		M5																																							
		1,2 Nm		3 Nm																																							
		11,5 lb.in. (1,3 Nm)		32 lb.in. (3,6 Nm)																																							
■	Connectable section:																																										
	Flexible conductors	n°. 1 min/max	mm ²		mm ²																																						
			AWG		AWG																																						
	Solid conductors	n°. 1 min/max	mm ²		mm ²																																						
			AWG		AWG																																						
■	Contacts	Slow opening double-break - Positive opening																																									
■	Opening angles	90°		90°																																							
■	Mechanical lifetime at 120 operations per hour mil/cl	nr. of cycles	0,1		0,1																																						
CERTIFICATIONS																																											
■	CE mark – Europa																																										
■	cUL Listed - Usa and Canada																																										
■	IMG Istituto Marchio Qualità - Italia																																										
■	CCC Cina																																										
■	GOST Russia																																										
♦ See p/n devices																																											
<table border="1"> <thead> <tr> <th></th> <th>SE16</th> <th>SE32</th> <th>SE63</th> <th>SE80</th> <th>SE100</th> </tr> </thead> <tbody> <tr> <td>■ Comply to the requirements by passed test</td> <td>■</td> <td>■</td> <td>■</td> <td>■</td> <td>■</td> </tr> <tr> <td>● Approved</td> <td>●</td> <td>●</td> <td>●</td> <td>●</td> <td>●</td> </tr> <tr> <td></td> <td>●</td> <td>●</td> <td>●</td> <td>●</td> <td>-</td> </tr> <tr> <td></td> <td>●</td> <td>●</td> <td>●</td> <td>●</td> <td>-</td> </tr> <tr> <td></td> <td>●</td> <td>●</td> <td>●</td> <td>●</td> <td>-</td> </tr> </tbody> </table>									SE16	SE32	SE63	SE80	SE100	■ Comply to the requirements by passed test	■	■	■	■	■	● Approved	●	●	●	●	●		●	●	●	●	-		●	●	●	●	-		●	●	●	●	-
	SE16	SE32	SE63	SE80	SE100																																						
■ Comply to the requirements by passed test	■	■	■	■	■																																						
● Approved	●	●	●	●	●																																						
	●	●	●	●	-																																						
	●	●	●	●	-																																						
	●	●	●	●	-																																						

Regolus

Switch - Disconnectors

SQ025-SQ063 Series - Mounting instructions

PANEL MOUNTING EXECUTION

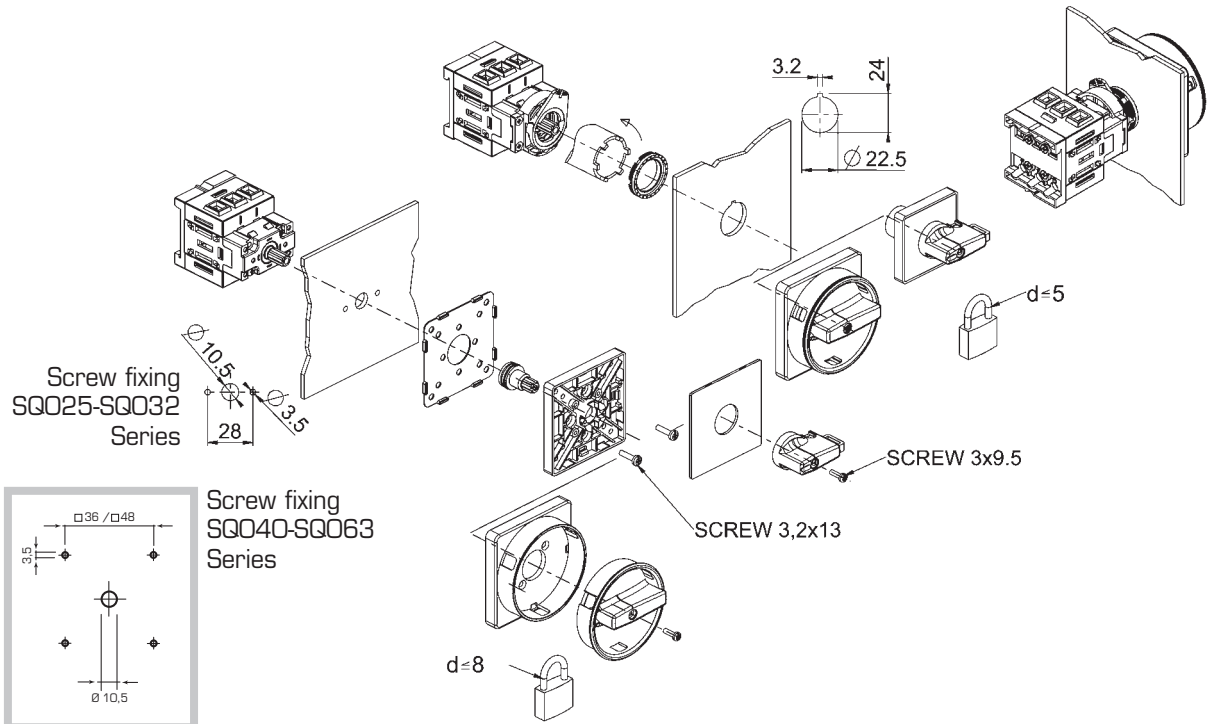

BOX EXECUTION

Alternative for SQ040-SQ063 Series

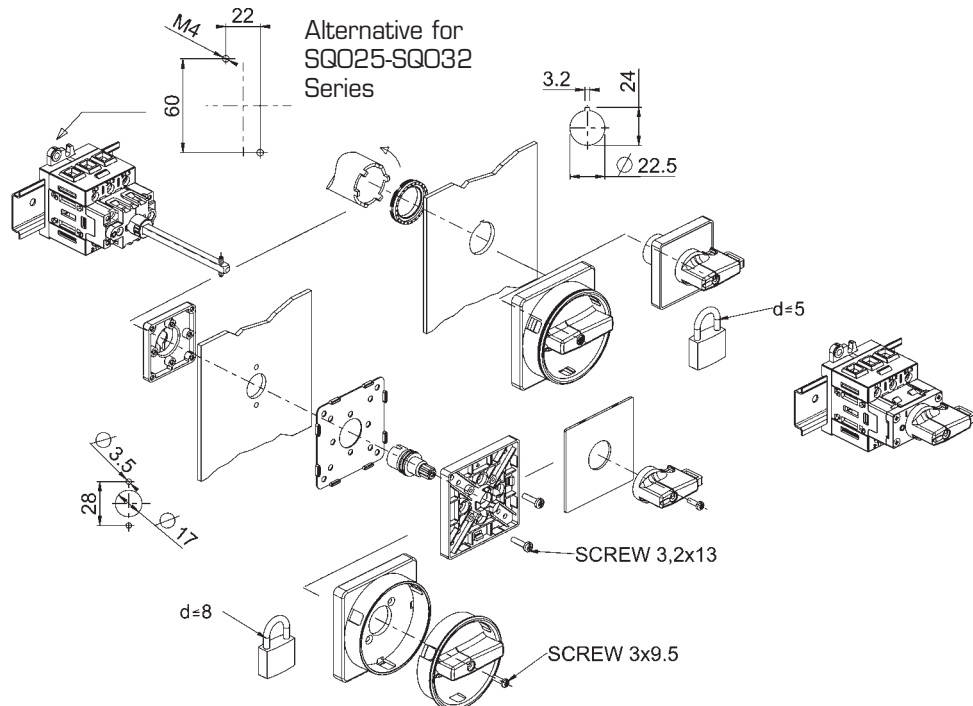
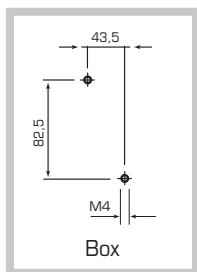

Regolus

Switch - Disconnectors

SQ125-SQ160 Series - Mounting instructions



AUTOMATION TECHNOLOGIES

PANEL MOUNTING EXECUTION

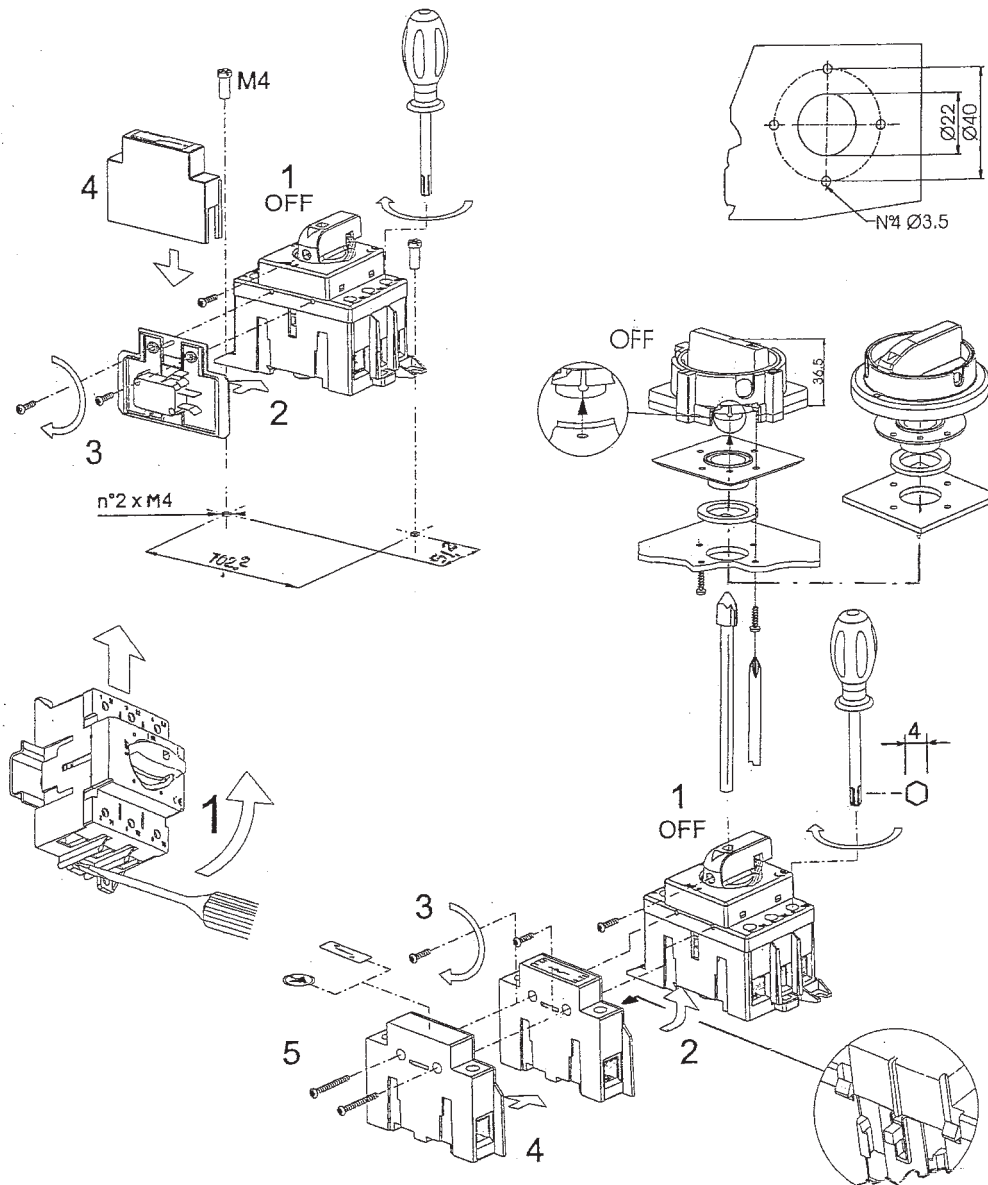

Regolus

Switch - Disconnectors

SE Series - Mounting instructions

PANEL MOUNTING EXECUTION

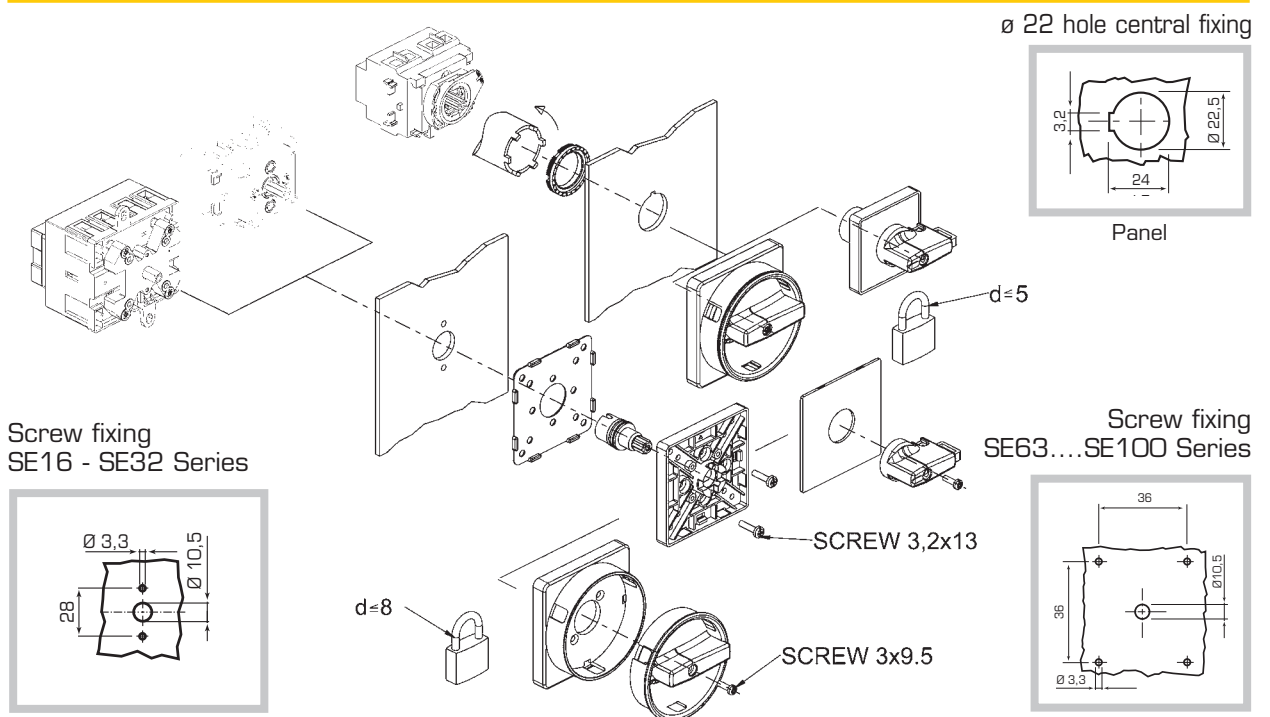

ENCLOSURE EXECUTION

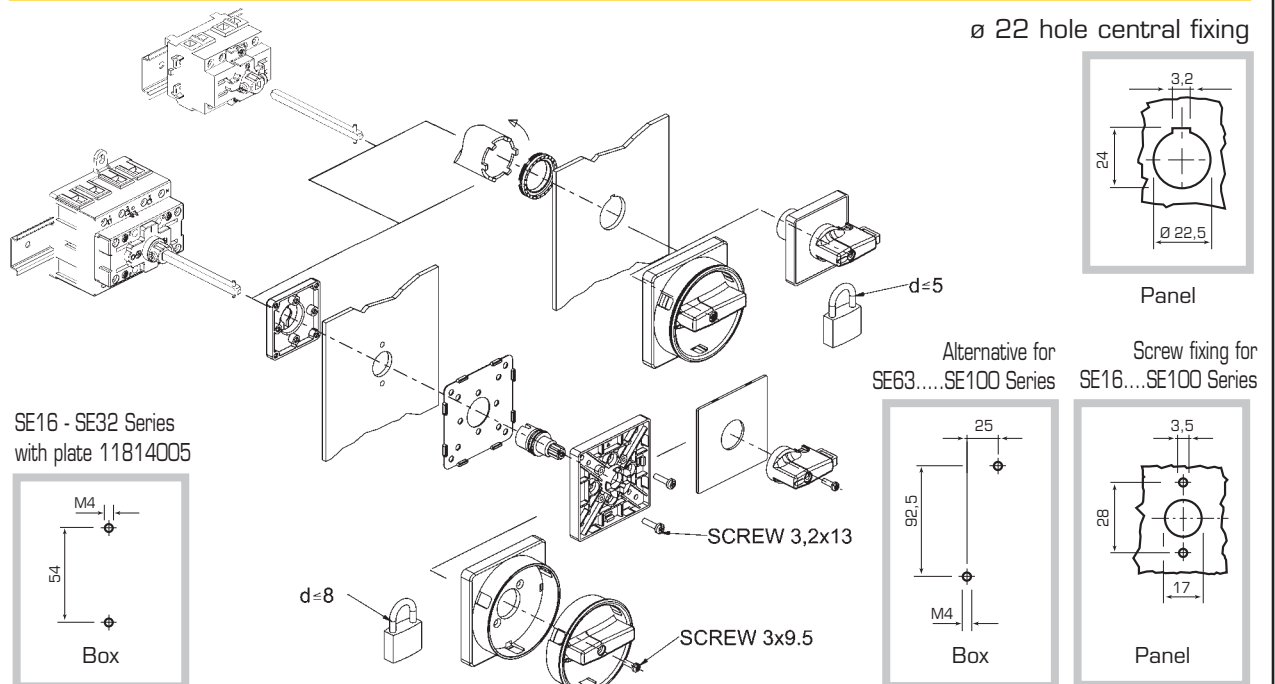

Regolus

Switch - Disconnectors

SQ025 SQ032 Series - Dimensions



AUTOMATION TECHNOLOGIES

Type B box fixing for door interlock - Command with screws fixing

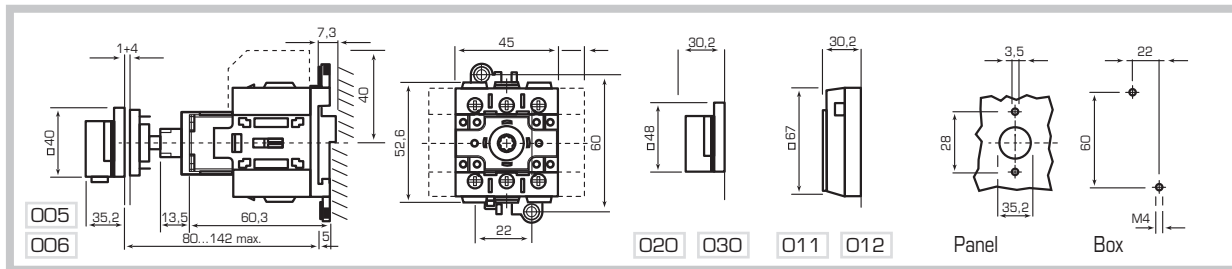

Type K box fixing for door interlock - Command with screws fixing

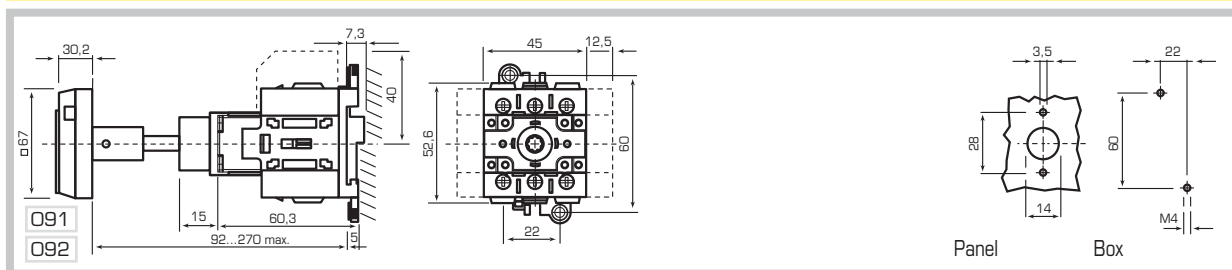

Type B box fixing for door interlock - Command central fixing ø 22

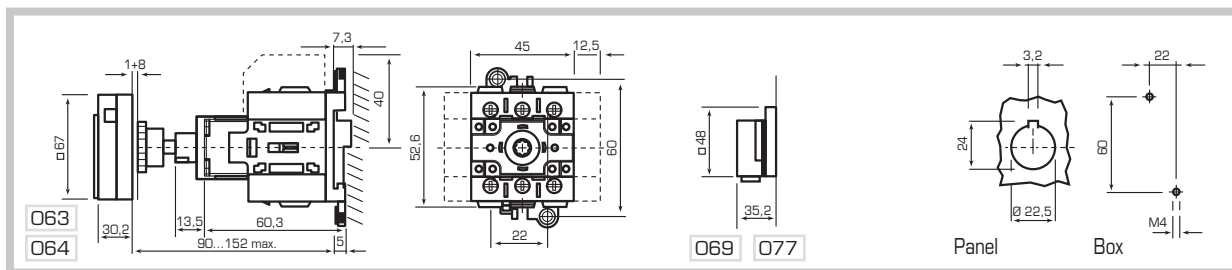

Type R rear panel mounting - Command with screws fixing

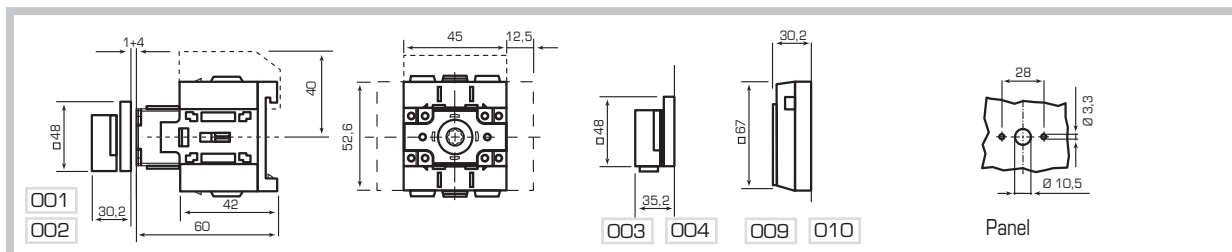

Type S rear panel mounting - Command central fixing ø 22

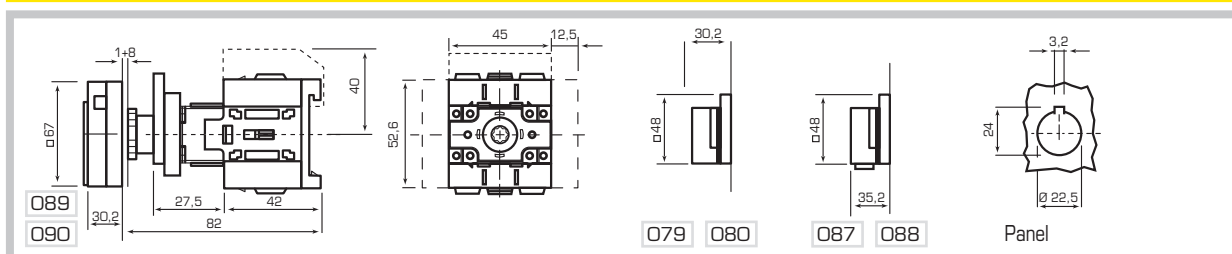

Regolus

Switch - Disconnectors

SQ025-SQ032 SQ040-SQ063 Series - Dimensions

Type D-L1N direct command box fixing - SQ025 SQ032 Series

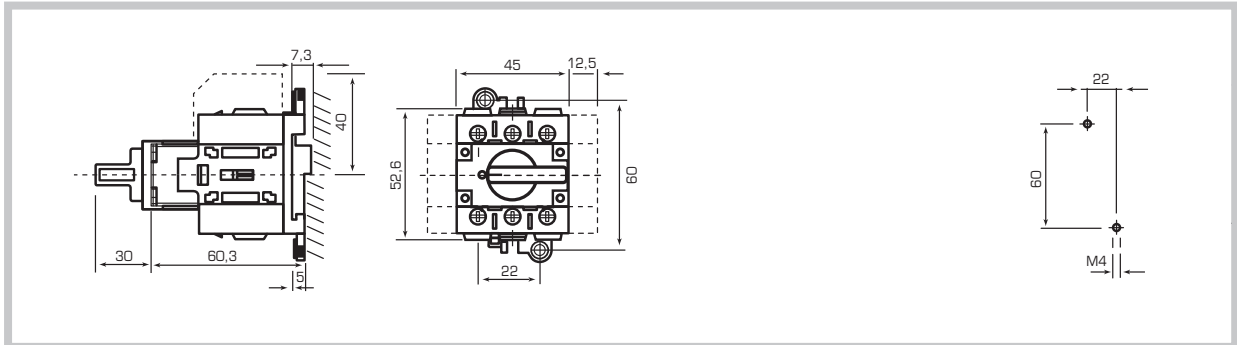

Type B box fixing for door interlock - SQ040-SQ063 Series

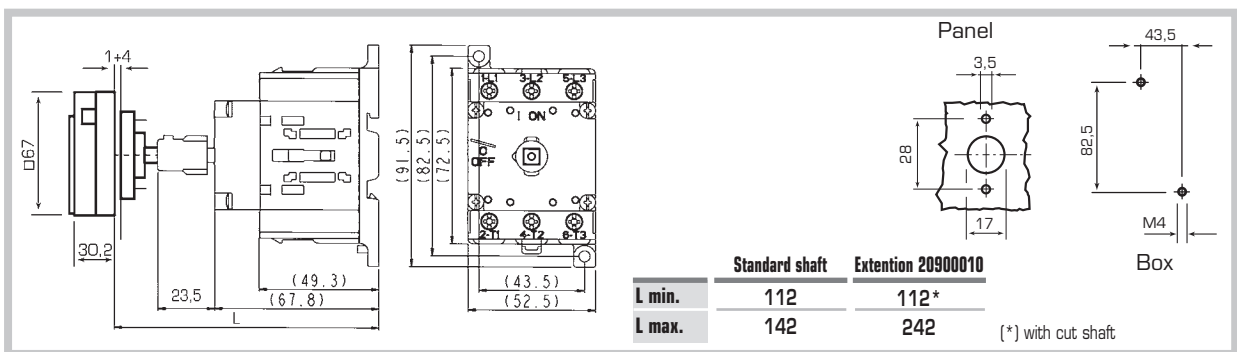

Type R rear panel mounting - SQ040-SQ063 Series

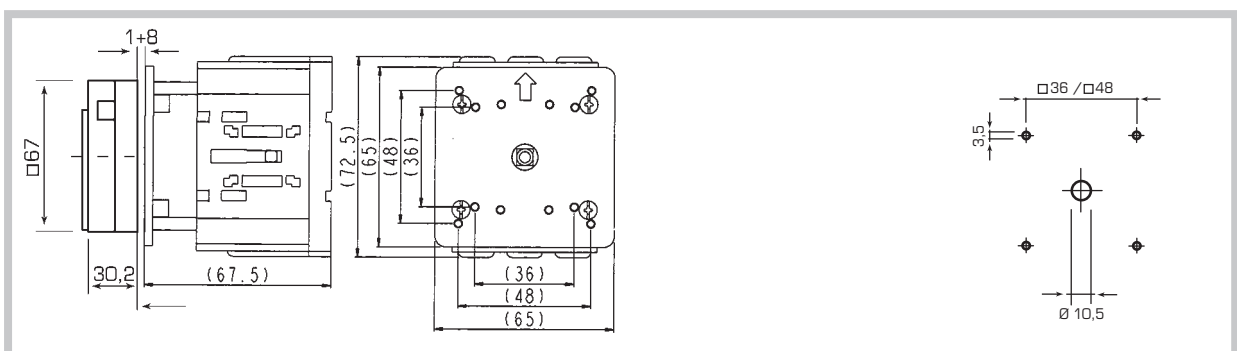

Type D-L2N direct command box fixing - SQ040-SQ063 Series

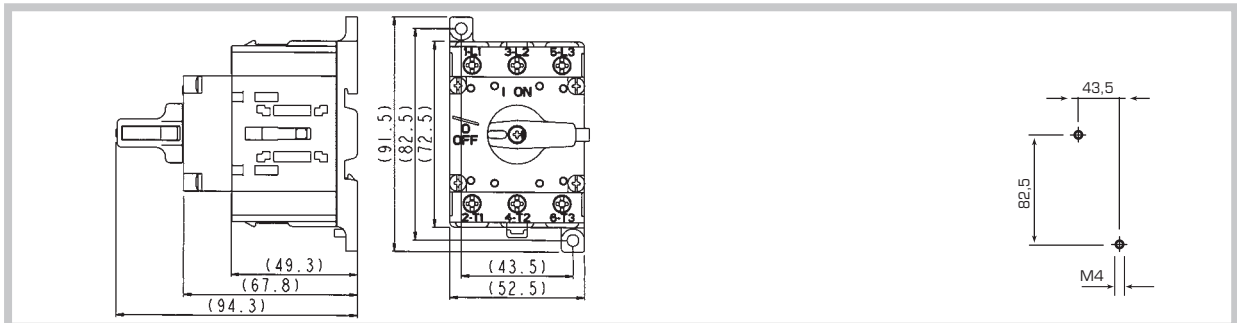

Regolus

Switch - Disconnectors SQ125-SQ160 Series - Dimensions



AUTOMATION TECHNOLOGIES

Type D-L2N direct command box fixing

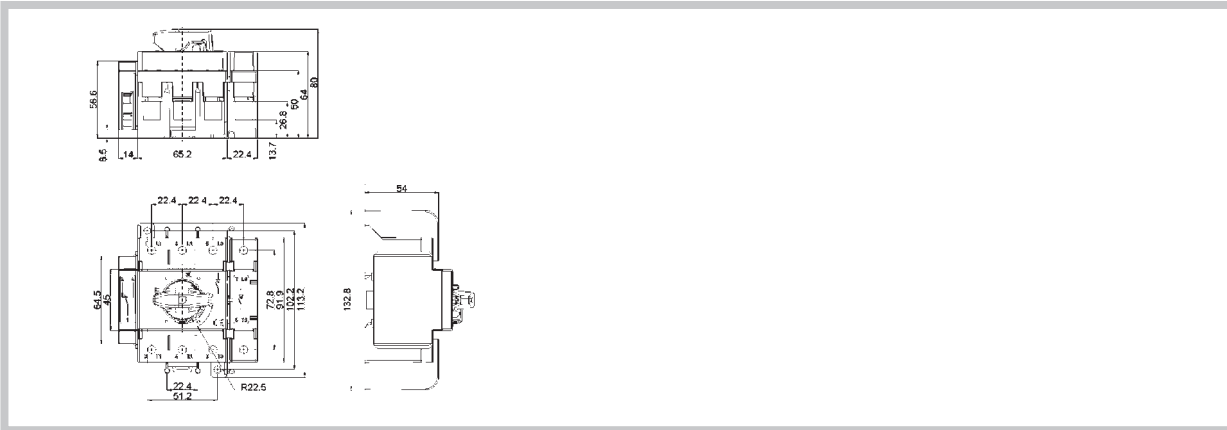

Box fixing for door interlock

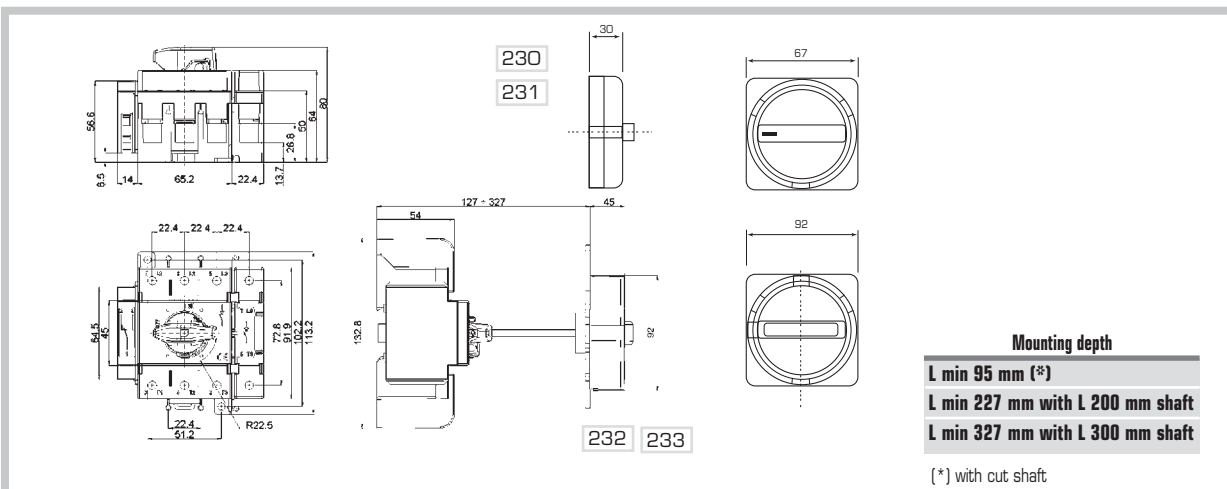

Regolus

Switch - Disconnectors

SE16 - SE100 Series - Dimensions

TYPE B BOX FIXING FOR DOOR INTERLOCK

SE16 - SE32 Series with screws fixing

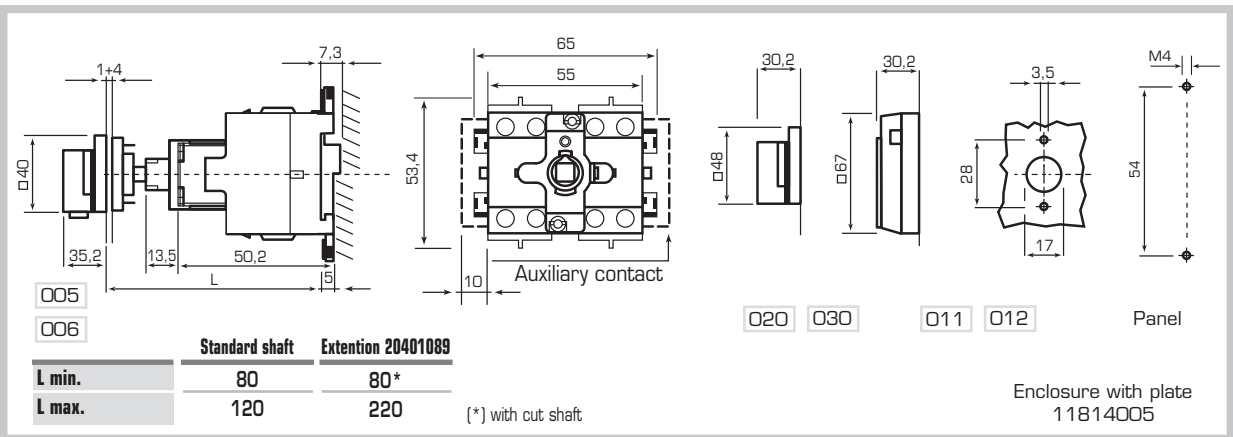

SE16 - SE32 Series with central fixing $\varnothing 22$

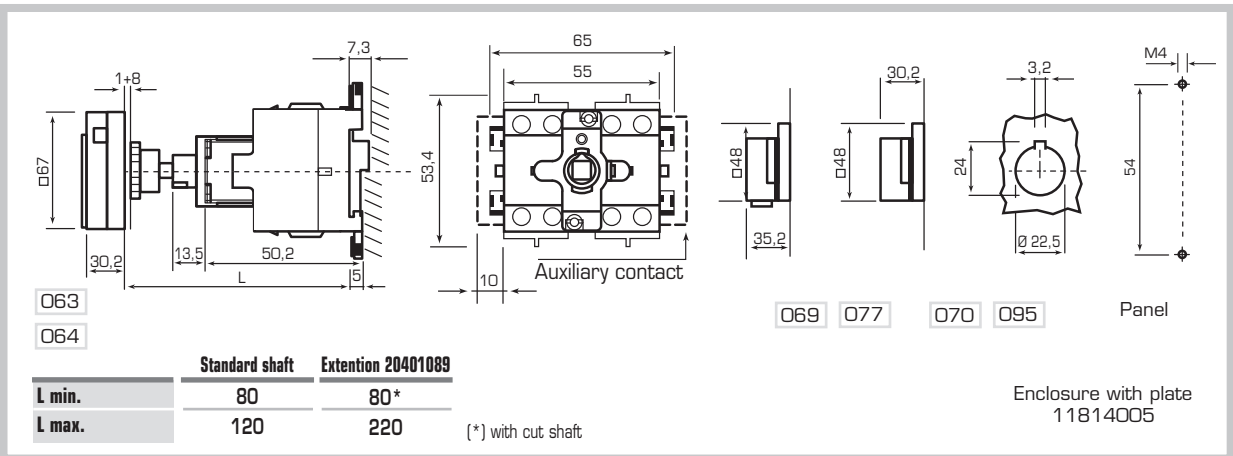

SE63 - SE100 Series with screws fixing

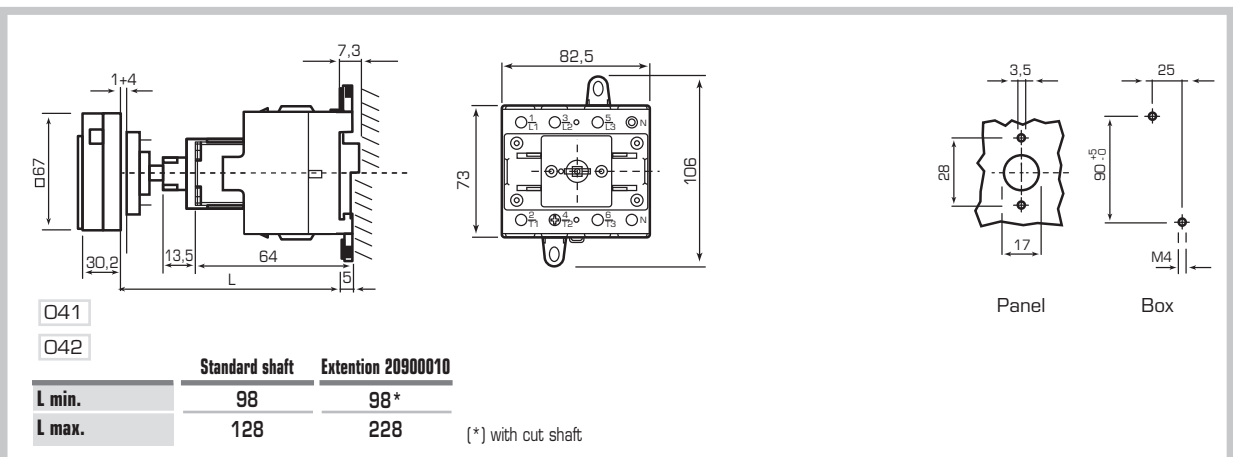

Regolus

Switch - Disconnectors

SE16 - SE100 Series - Dimensions



AUTOMATION TECHNOLOGIES

Type R rear panel mounting - Command with screws fixing SE16-SE32 Series

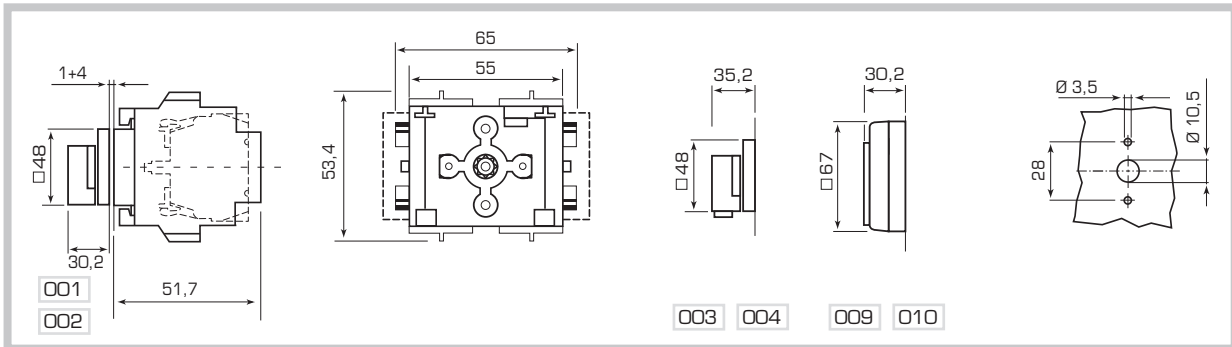

Type S rear panel mounting - Command central fixing $\varnothing 22$ SE16-SE32 Series

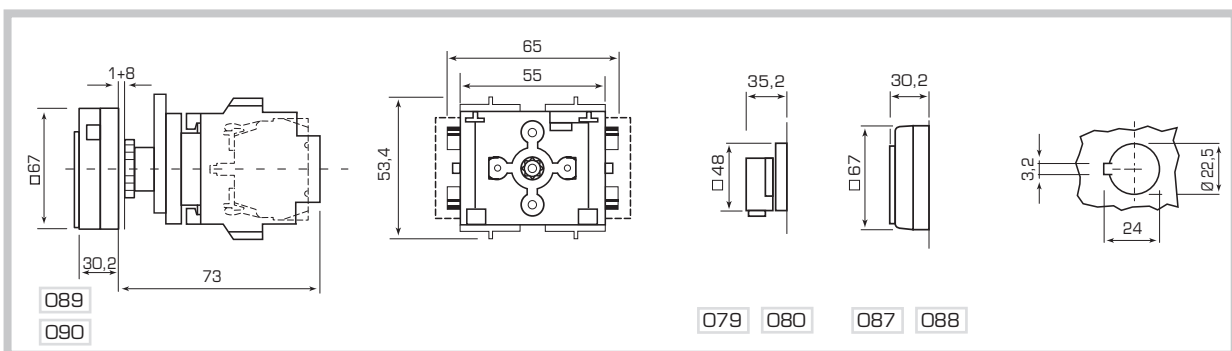

Type S rear panel mounting - Command central fixing $\varnothing 22$ SE16-SE32 Series

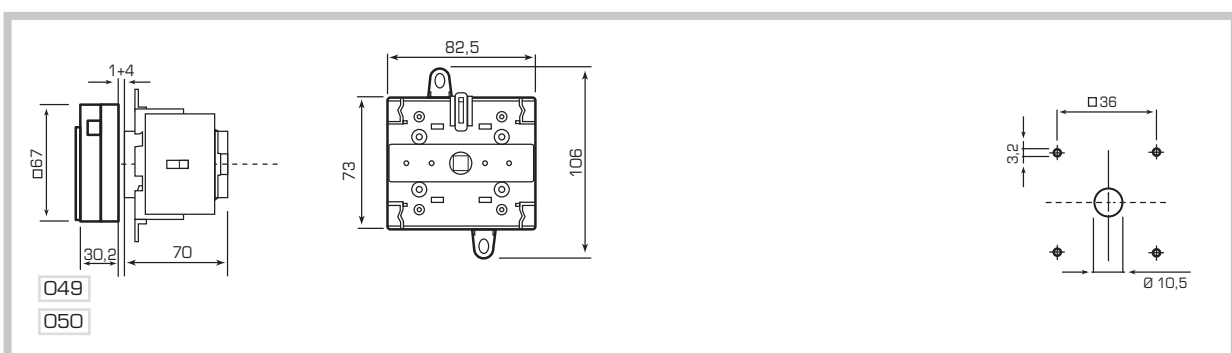

Regolus

Switch - Disconnectors

Enclosure installation - Dimensions

ENCLOSURE INSTALLATION

C01 - C09 - C10

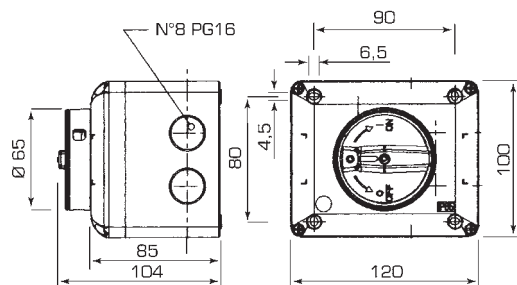

E01 - E09 - E10

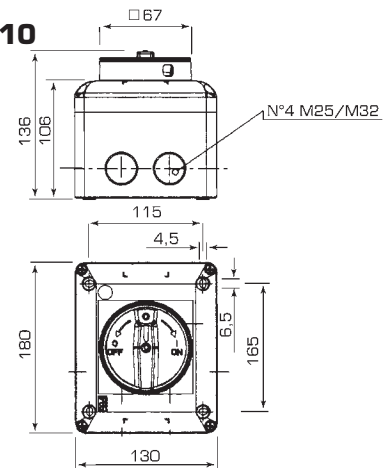

C41 - C42

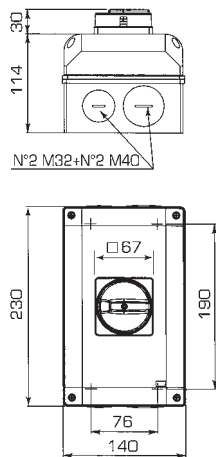

A09 - A10

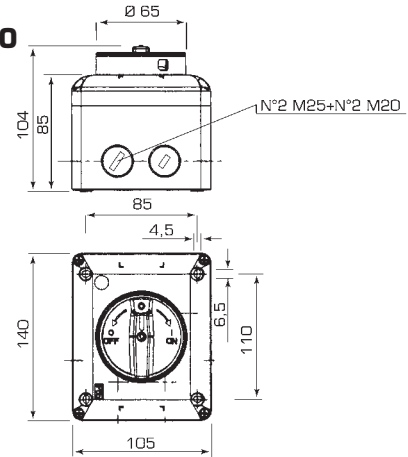

AB9 - ABO

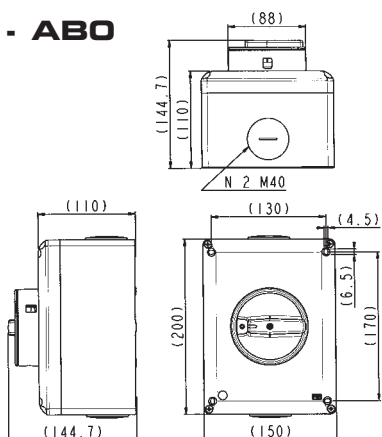

Pegasus

Control auxiliaries Ø 22

Table of contents



AUTOMATION TECHNOLOGIES



Panel mounting on Ø 22,5 mm holes, IP65 protection rating, available with “Black line” or “Nickel line” frames, EN ISO 13850 emergency mushrooms, terminals with screws, spring loaded or for printed circuit boards. Push button stations up to 3 gang or empty enclosures up to 6 gang. Version for pneumatic systems.

TABLE OF CONTENTS

■ Assembly	pag. 72	■ Pegasus Series	pag. 81
■ Pegasus Series - Black line		■ Multi function push buttons Ø 22	pag. 84
■ Push buttons Ø 22	pag. 73	■ Contacts Blocks	pag. 85
■ Rotary Switch Ø 22	pag. 74	■ Push buttons station	pag. 88
■ Push buttons Ø 22	pag. 75	■ Auxiliaries of command Ø 22	pag. 93
■ Single light Ø 22	pag. 76	■ pneumatic valve adapters	
■ Multi function push buttons Ø 22	pag. 77	■ Auxiliaries of command Ø 22	pag. 94
■ Pegasus Series - Nickel line		■ Accessories	
■ Push buttons Ø 22	pag. 78	■ Push buttons Ø 22	pag. 95
■ Rotary Switch Ø 22	pag. 79	■ Dates and Symbology	
■ Multi function push buttons Ø 22	pag. 81	■ Electrical characteristics	pag. 96
■ Emergency Push buttons Ø 22	pag. 82	■ Caratteristiche Generali	pag. 97

Pegasus

Control auxiliaries

Assembly instructions

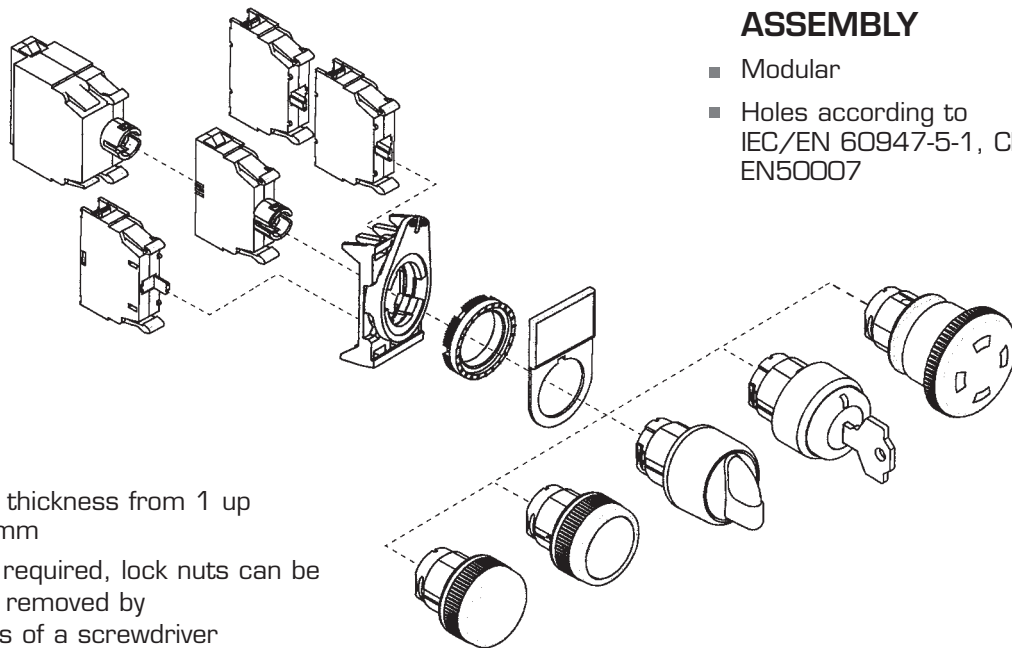

ASSEMBLY

- Panel thickness from 1 up to 6 mm
- If not required, lock nuts can be easily removed by means of a screwdriver

- Modular
- Holes according to IEC/EN 60947-5-1, CENELEC EN50007

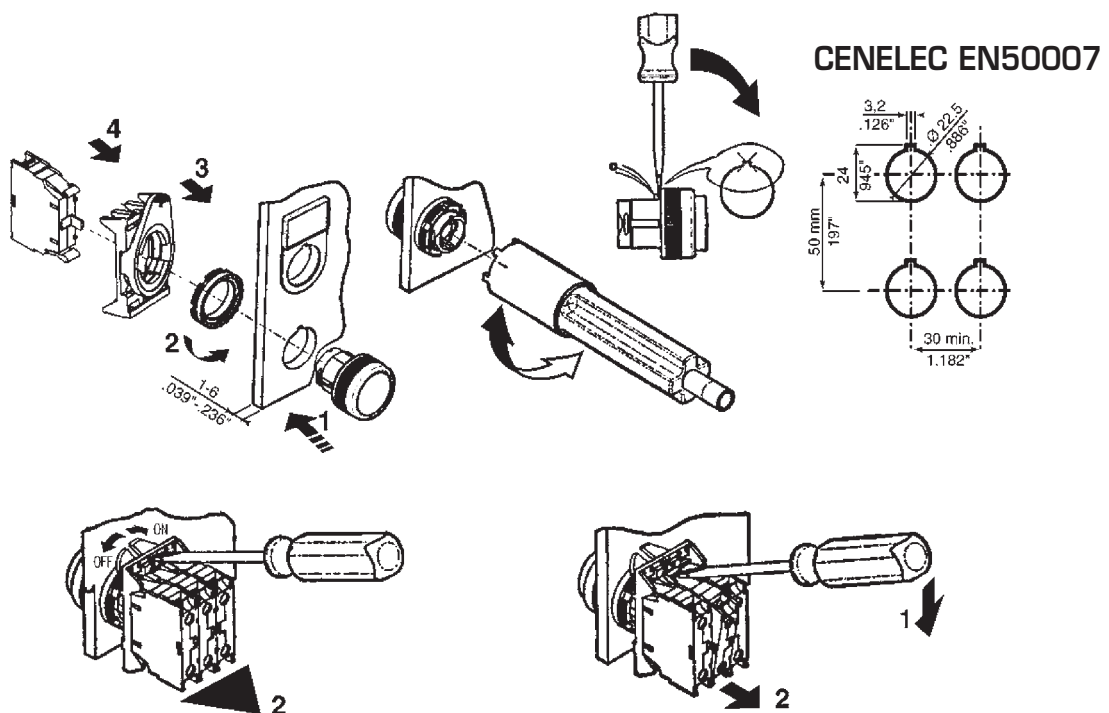

Pegasus

Push buttons \varnothing 22

With colour cap - Black line



AUTOMATION TECHNOLOGIES

MOMENTARY	DESCRIPTION	COL. INDEX	CODE	WEIGHT gr	MIN. PACK QTY.	DIMENSIONS
	Flush push button		PPRN1	30	10	
			PPRN2	30	10	
			PPRN3	30	10	
			PPRN4	30	10	
			PPRN5	30	10	
			PPRN8	30	10	
	Extended push button		PPSN1	31	10	
			PPSN2	31	10	
			PPSN3	31	10	
			PPSN4	31	10	
			PPSN5	31	10	
			PPSN8	31	10	
	Flush reset push button		PPRN4R	43	10	
	Mushroom \varnothing 40		PPFN1M4N	35	10	
			PPFN2M4N	35	10	
			PPFN3M4N	35	10	
	Mushroom \varnothing 60		PPFN1M6N	40	10	
LATCHED						
	Flush push button		PPP1N1	32	10	
			PPP1N2	32	10	
			PPP1N3	32	10	
			PPP1N4	32	10	
			PPP1N5	32	10	
			PPP1N8	32	10	
	Mushroom operator \varnothing 40		PPFN1S4N	35	10	
			PPFN2S4N	35	10	
			PPFN3S4N	35	10	

Pegasus

Rotary switches ø 22

Standard and with lens - Black line

WITH SHORT OPERATOR



WITH LONG OPERATOR



WITH KEY



POSITIONS	WITH SHORT OPERATOR		WITH LONG OPERATOR		KEY REMOVAL			CODE
	COL. INDEX	CODE	COL. INDEX	CODE	L	O	R	
 90°		PSMB1DO		PSLB1DO		*		PSCR8DOC
		PSMB2DO		PSLB2DO				
		PSMB3DO		PSLB3DO				
		PSMB4DO		PSLB4DO			*	PSCR8DOE
		PSMB5DO		PSLB5DO		*	*	PSCR8DON
		PSMB8DO		PSLB8DO				
 45°		PSMB1D2		PSLB1D2				PSCR8D2C
		PSMB2D2		PSLB2D2		*		
		PSMB3D2		PSLB3D2				
		PSMB4D2		PSLB4D2				
		PSMB5D2		PSLB5D2				
		PSMB8D2		PSLB8D2				
 45°		PSMB1T0		PSLB1T0	*	*		PSCR8TOC
		PSMB2T0		PSLB2T0				PSCR8TOA
		PSMB3T0		PSLB3T0			*	PSCR8TOE
		PSMB4T0		PSLB4T0	*	*	*	PSCR8TOG
		PSMB5T0		PSLB5T0	*	*	*	PSCR8TOH
		PSMB8T0		PSLB8T0	*	*	*	PSCR8TOK
								PSCR8TON
 45°		PSMB1T3		PSLB1T3				PSCR8T3C
		PSMB2T3		PSLB2T3				
		PSMB3T3		PSLB3T3		*		
		PSMB4T3		PSLB4T3				
		PSMB5T3		PSLB5T3				
		PSMB8T3		PSLB8T3				
 45°		PSMB1T2		PSLB1T2		*		PSCR8T2C
		PSMB2T2		PSLB2T2				
		PSMB3T2		PSLB3T2	*			PSCR8T2A
		PSMB4T2		PSLB4T2				
		PSMB5T2		PSLB5T2	*	*		PSCR8T2H
		PSMB8T2		PSLB8T2				
 45°		PSMB1T1		PSLB1T1		*		PSCR8T1C
		PSMB2T1		PSLB2T1				
		PSMB3T1		PSLB3T1			*	PSCR8T1E
		PSMB4T1		PSLB4T1				
		PSMB5T1		PSLB5T1		*	*	PSCR8T1N
		PSMB8T1		PSLB8T1				

1 For standard rotary switches suitable to operate a central contact, replace the letter "B" with the letter "C": PSMC...

2 For rotary switches with Left-Right operating angles replace the letter "DO" with "SD" PSMB1DO or PSCR8SDE...
For key removal, see position 45° and relative final codes.

* Key removal position

Pegasus





Push buttons $\varnothing 22$

With lens cap - Black line



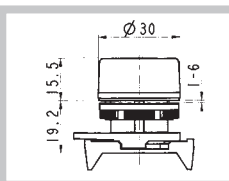

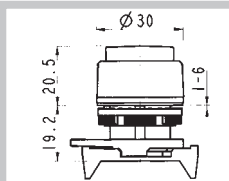
AUTOMATION TECHNOLOGIES

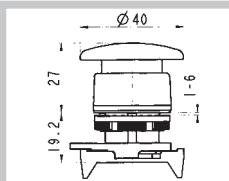
MOMENTARY PUSH BUTTONS

	DESCRIPTION	COL. INDEX	CODE	WEIGHT gr	MIN. PACK QTY.	DIMENSIONS
	Flush push button	■	PPRL1	30	10	
		■	PPRL2	30	10	
		■	PPRL3	30	10	
		■	PPRL4	30	10	
		■	PPRL5	30	10	
	Extended push button	■	PPSL1	31	10	
		■	PPSL2	31	10	
		■	PPSL3	31	10	
		■	PPSL4	31	10	
		■	PPSL5	31	10	
	Mushroom operator $\varnothing 40$	■	PPFL1M4N	35	10	

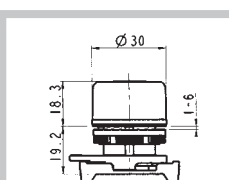
LATCHED PUSH BUTTONS

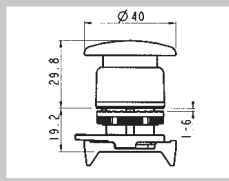
	Flush push button	■	PPPL1	32	10	
		■	PPPL2	32	10	
		■	PPPL3	32	10	
		■	PPPL4	32	10	
		■	PPPL5	32	10	
	Mushroom operator $\varnothing 40$	■	PPFL1S4N	35	10	
		■	PPFL2S4N	35	10	
		■	PPFL3S4N	35	10	

INDICATOR LIGHT

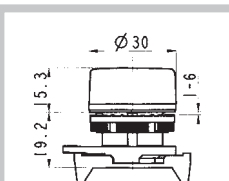
	Flat cap	■	PLSL1	30	10	
		■	PLSL2	30	10	
		■	PLSL3	30	10	
		■	PLSL4	30	10	
		■	PLSL5	30	10	

Pegasus

LED pilot lights $\varnothing 22$

With colour caps - Black line

LED PILOT LIGHTS



DESCRIPTION	POWER SUPPLY	CODE	WEIGHT gr	MIN. PACK QTY.
Single LED indicator X1 —  X2	AC/DC 6V 1	PLML 2 L6	15	10
	AC/DC 12V 1	PLML 2 L12	15	10
	AC/DC 24V	PLML 2 L24	15	10
	AC/DC 48V	PLML 2 L48	15	10
	AC/DC 110V	PLML 2 L110	15	10
	AC 220V	PLML 2 L220	15	10
	AC 380V 1	PLML 2 L380	15	10

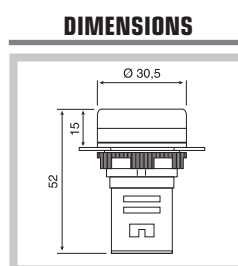

MAIN TECHNICAL DATAS

Comply with rules		EN60947-5-1 - GB14048.5
Operational temperature	C°	-5 +40
Operational umidity		45%90%
AC rated frequency	Hz	50/60
Rated insulation voltage	1 min. V	2500V
Over voltage category	EN60947.1	III
Pollution grade	EN60947.1	3
Protection degree	EN60529	IP65, IP2X terminals
Connection:		
Terminal block caliber		A2
Terminal screw		M3,5
Flexible and solid conductors section	min./max.	n.1 1/2,5 mm ² - n.2 1/2,5 mm ²
Rated operational voltage Ue	AC/DC V	6 12, 24, 48, 110
	AC V	220 - 380
Rated operating current Ie	mA	≤ 80 6,12V
	mA	≤ 20 24, 48, 110, 220, 380
Electrical life	h	≥ 30.000
Brightness	cd/m ²	≥ 60
Mounting		∅ 22,5

DIAGRAM

Resistance

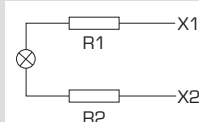



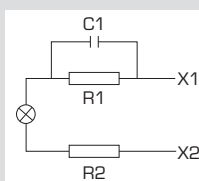



Capacity resistance



AC 220....380V

PILOT LIGHT



DESCRIPTION	COL. INDEX	CODE	WEIGHT gr	MIN. PACK QTY.
Single lampholder indicator BA9s Lamp not included X1 —  X2 AC/DC 250V max. 2W		PLML1	15	10
		PLML2	15	10
		PLML3	15	10
		PLML4	15	10
		PLML5	15	10

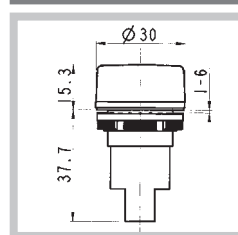

1 On demand execution

2 Insert lens colour code: 1 - red, 2 - green, 3 - yellow, 4 - blue, 5 - white

Pegasus









Multifunction push button \varnothing 22

Light and lens=multifunction push button light-lens - Black line

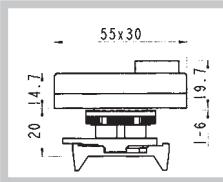

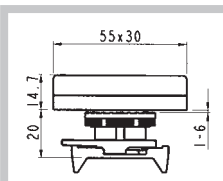



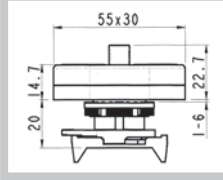

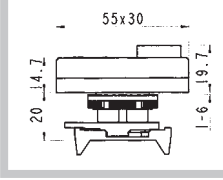

AUTOMATION TECHNOLOGIES

MULTIFUNCTION PUSH BUTTON - NOT LIGHT

	DESCRIPTION	COL. - SYMBOL	CODE	WEIGHT gr	MIN. PACK QTY.	DIMENSIONS
	Dual push button		PPDN	38	10	
	Flush dual push button		PPDNR	38	10	
			PPDNR.3	38	10	
	Triple push button		PPMN	40	10	

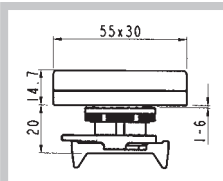
MULTIFUNCTION PUSH BUTTON - LIGHT

	Dual push button		PPDL	30	10	
			PPDL.1	30	10	
	Flush dual push button		PPDLR	30	10	
			PPDLR.3	30	10	

Multi-function push buttons - Special symbols and text for horizontal assembly/identification are available on request













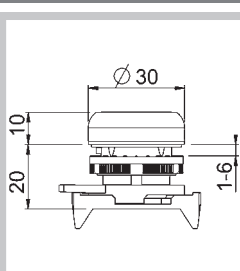





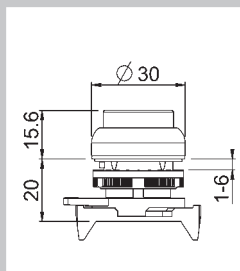

Pegasus

Push buttons \varnothing 22



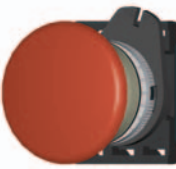

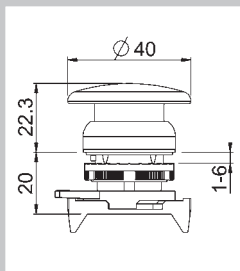



Not light - Nickel line - IP67

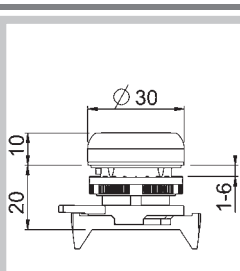

MOMENTARY PUSH BUTTONS

	DESCRIPTION	COL. INDEX	CODE	WEIGHT gr	MIN. PACK QTY.	DIMENSIONS
	Flush Push Button		PPRN1NL	30	10	
			PPRN2NL	30	10	
			PPRN3NL	30	10	
			PPRN4NL	30	10	
			PPRN5NL	30	10	
			PPRN8NL	30	10	
	Extended Push Button		PPSN1NL	31	10	
			PPSN2NL	31	10	
			PPSN3NL	31	10	
			PPSN4NL	31	10	
			PPSN5NL	31	10	
			PPSN8NL	31	10	
	Mushroom \varnothing 40		PPFN1M4NNL	45	10	
			PPFN2M4NNL	45	10	
			PPFN3M4NNL	45	10	

LATCHED PUSH BUTTONS

	DESCRIPTION	COL. INDEX	CODE	WEIGHT gr	MIN. PACK QTY.	DIMENSIONS
	Flush Push Button		PPPN1NL	31	10	
			PPPN2NL	31	10	
			PPPN3NL	31	10	
			PPPN4NL	31	10	
			PPPN5NL	31	10	
			PPPN8NL	31	10	

Pegasus

Rotary Switches \varnothing 22

Not Light and Light - Nickel line - IP66



AUTOMATION TECHNOLOGIES

WITH SHORT OPERATOR

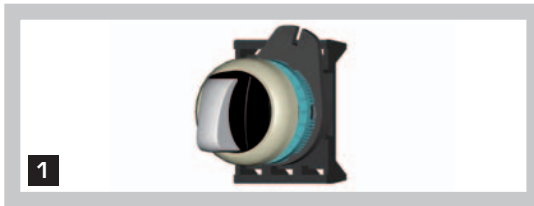

WITH KEY

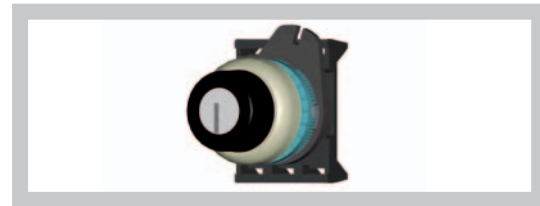

POSITIONS	COL. INDEX	CODE	KEY REMOVAL			CODE
			L	O	R	
 90°		PSMB1DONL		*		PSCR8DOCNL
		PSMB2DONL				
		PSMB3DONL				
		PSMB4DONL			*	PSCR8DOENL
		PSMB5DONL		*	*	PSCR8DONNL
		PSMB8DONL				
 45°		PSMB1D2NL				PSCR8D2CNL
		PSMB2D2NL				
		PSMB3D2NL		*		
		PSMB4D2NL				
		PSMB5D2NL				
		PSMB8D2NL				
 45°		PSMB1TONL		*		PSCR8TOCNL
		PSMB2TONL	*			PSCR8TOANL
		PSMB3TONL			*	PSCR8TOENL
		PSMB4TONL	*	*	*	PSCR8TOGNL
		PSMB5TONL	*	*	*	PSCR8TOHNL
		PSMB8TONL	*	*	*	PSCR8TOKNL
			*	*	PSCR8TONNL	
 45°		PSMB1T3NL				PSCR8T3CNL
		PSMB2T3NL				
		PSMB3T3NL		*		
		PSMB4T3NL				
		PSMB5T3NL				
		PSMB8T3NL				
 45°		PSMB1T2NL		*		PSCR8T2CNL
		PSMB2T2NL				
		PSMB3T2NL	*			PSCR8T2ANL
		PSMB4T2NL				
		PSMB5T2NL	*	*		PSCR8T2HNL
		PSMB8T2NL				
 45°		PSMB1T1NL		*		PSCR8T1CNL
		PSMB2T1NL				
		PSMB3T1NL			*	PSCR8T1ENL
		PSMB4T1NL				
		PSMB5T1NL		*	*	PSCR8T1NNL
		PSMB8T1NL				

1 The rotary switches with out light suitable to operate a central contact, replace the letter "B" with the letter "C": PSMC....

2 For rotary switches with Left-Right operating angles replace the letter "DO" with "SD" PSMB1DO or PSCR8SDE...
For key removal, see position 45° and relative final codes.

* Key removal position













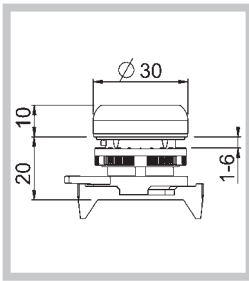

Pegasus

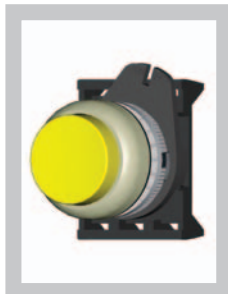
Push buttons \varnothing 22

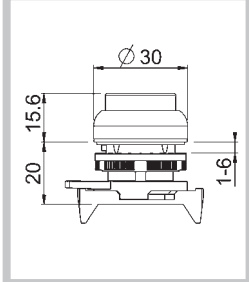



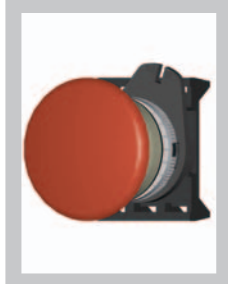

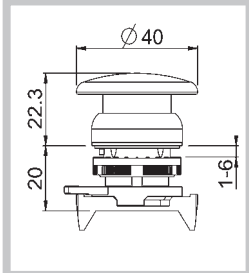
With lens cap - Nickel line - IP67

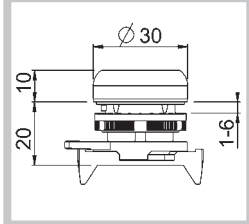

MOMENTARY PUSH BUTTONS

	DESCRIPTION	COL. INDEX	CODE	WEIGHT gr	MIN. PACK QTY.	DIMENSIONS
	Flush Push Button		PPRL1NL	30	10	
			PPRL2NL	30	10	
			PPRL3NL	30	10	
			PPRL4NL	30	10	
			PPRL5NL	30	10	
	Extended Push Button		PPSL1NL	31	10	
			PPSL2NL	31	10	
			PPSL3NL	31	10	
			PPSL4NL	31	10	
			PPSL5NL	31	10	
	Mushroom \varnothing 40		PPFL1M4NNL	43	10	

LATCHED PUSH BUTTONS

	DESCRIPTION	COL. INDEX	CODE	WEIGHT gr	MIN. PACK QTY.	DIMENSIONS
	Flush Push Button		PPPL1NL	31	10	
			PPPL2NL	31	10	
			PPPL3NL	31	10	
			PPPL4NL	31	10	
			PPPL5NL	31	10	







Pegasus

Multi function push buttons ø 22
Nickel line - IP67



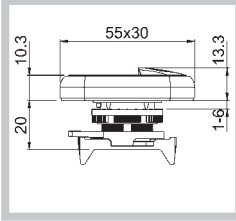

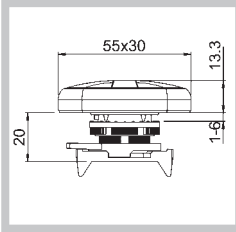

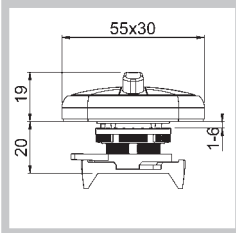

AUTOMATION TECHNOLOGIES

MULTI FUNCTION PUSH BUTTONS

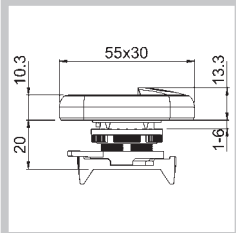
	DESCRIPTION	COL. - SYMBOL	CODE	WEIGHT gr	Min. Pack Qty.	DIMENSIONS
	Dual Push Button		PPDNNL	38	10	
	Extended Push Button		PPDNSNL	38	10	
	Triple multi function		PPMNSNL	40	10	

MULTI FUNCTION PUSH BUTTONS - WITH LIGHT-LENS

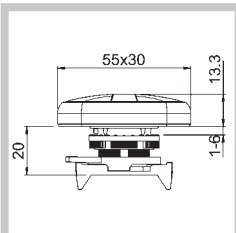
	Dual Push Button		PPDLNL	38	10	
			PPDLNL.1	38	10	
	Extended double push button		PPDLSNL	38	10	











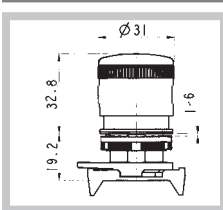

1 On demand execution

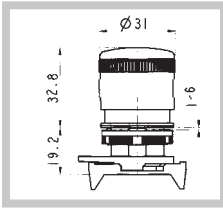
Multifunction push buttons - On demand we can provide special symbol or writings for horizontal mounting/reading

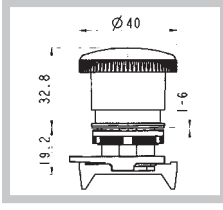
Pegasus

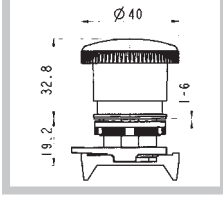
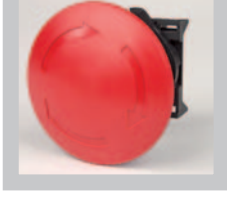
Emergency push buttons \varnothing 22

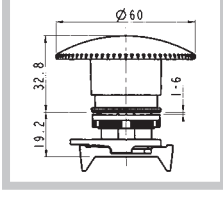
EN ISO 13850

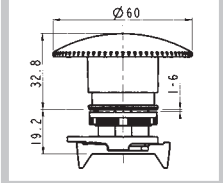







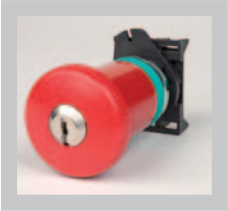

	DESCRIPTION	COLOUR	CODE	WEIGHT gr	MIN. PACK QTY.	DIMENSIONS
	Mushroom operator \varnothing 30 twist to release		PPFN1R3N	42	10	
	Mushroom operator with vision \varnothing 30 twist to release		PPFN1R3S	44	10	
	Mushroom operator \varnothing 40 twist to release		PPFN1R4N	44	10	
	Mushroom operator with vision \varnothing 40 twist to release		PPFN1R4S	46	10	
	Mushroom operator \varnothing 60 twist to release		PPFN1R6N	50	10	
	Mushroom operator with vision \varnothing 60 twist to release		PPFN1R6S	52	10	

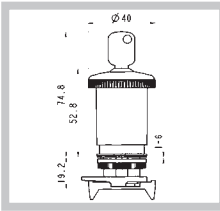
Pegasus

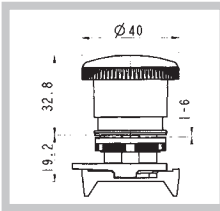
Emergency push buttons ø 22 EN ISO 13850

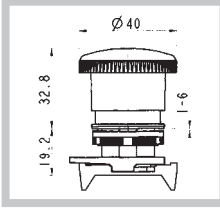

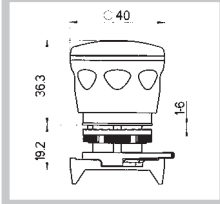
AUTOMATION TECHNOLOGIES

	DESCRIPTION	COLOUR	CODE	WEIGHT gr	MIN. PACK QTY.	DIMENSIONS
	Mushroom operator ø 40 with key release		PPFN1C4N	76	10	
	Mushroom operator ø 40 push-pull		PPFN1P4N	44	10	
	Mushroom operator ø 40 push-pull with vision		PPFN1P4S	46	10	
	Mushroom operator ø 40 push-pull with colour cap		PPFN1P4C	45	10	
	Mushroom operator ø 40 push-pull with lens cap		PPFL1P4N	45	10	

TECHNICAL NOTES

- All operators comply with the relevant European standard
- EN ISO 13850 Machine safety Emergency stop operators, functional characteristics - Design guidelines
- IEC/EN60947-5-1
- Comply with the standard IEC/EN60204-1: Machine safety Machine electrical circuits General guidelines
- The push buttons are designed with a load charge mechanism to ensure a reliable operation and stoppage, or blockage, in the activated position. The combination with positive switching NC ⊖ contacts and the presence of the "status" indicator on some models, guarantee a high degree of reliability and effectiveness.

Pegasus

Joystick operators $\varnothing 22$ IP65

JOYSTICK OPERATORS

CONTACT BLOCKS		2 POSITIONS						4 POSITIONS				
		HORIZONTAL			VERTICAL			3	1	0	2	4
		1	0	2	1	0	2					
Left-hand side contact block	NO	X	0	0	0	0	X	X	0	0	0	0
	NC	0	0	X	X	0	0	0	0	0	0	X
Right-hand side contact block	NO	0	0	X	X	0	0	0	X	0	0	0
	NC	X	0	0	0	0	X	0	0	0	X	0

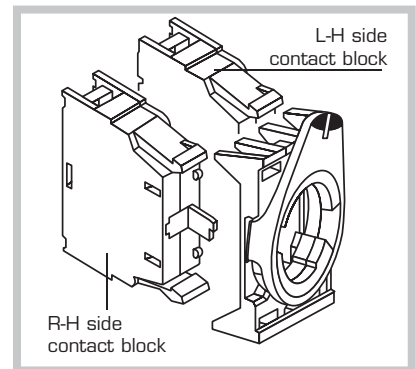

X Contact close
0 Contact open

POSITIONS



CODE	CODE	CODE	CODE
PMJN8T0	PMJN8T3	PMJN8Q0	PMJN8Q4
CODE	CODE		
PMJN80S	PMJN80R		

WEIGHT gr

MIN. PACK QTY.

DIMENSIONS

54

5

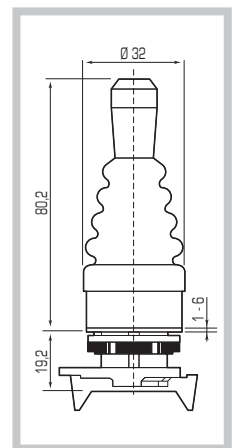

CODE	CODE	CODE	CODE
PMJN8T01	PMJN8T31	PMJN8Q01	PMJN8Q41
CODE	CODE		
PMJN80S1	PMJN80R1		

54

5

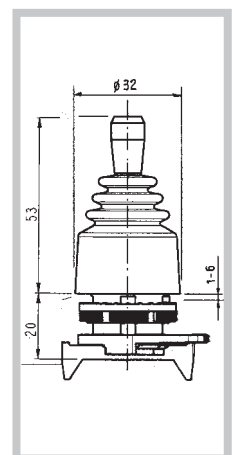

Pegasus



Contact blocks

Spring loaded Terminals

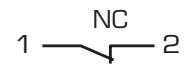

AUTOMATION TECHNOLOGIES

SPRING LOADED TERMINALS

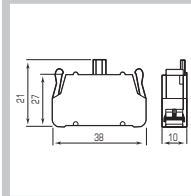
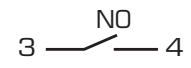
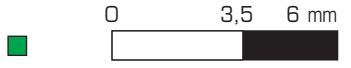
		CONTACT BLOCKS			
	DESIGNATION	FUNCTIONS	CODE	DIMENSIONS	
			PCW01		
					

LAMPHOLDER BA9s

	DESIGNATION	POWER SUPPLY	CODE	DIMENSIONS
		BA9s lamp socket 250V 2,4 w max bulb not included	PCWAD	

LAMPHOLDER WITH BUILT-IN LED

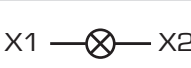
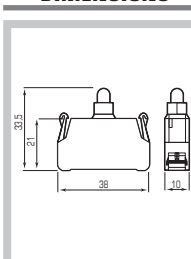
	DESIGNATION	POWER SUPPLY	CODE	DIMENSIONS
		AC/DC 12V	PCW5L12	
		AC/DC 24V	PCW5L24	
		AC/DC 48V	PCW5L48	
		AC/DC 110V	PCW5L110	
		AC 220V	PCW5L220	

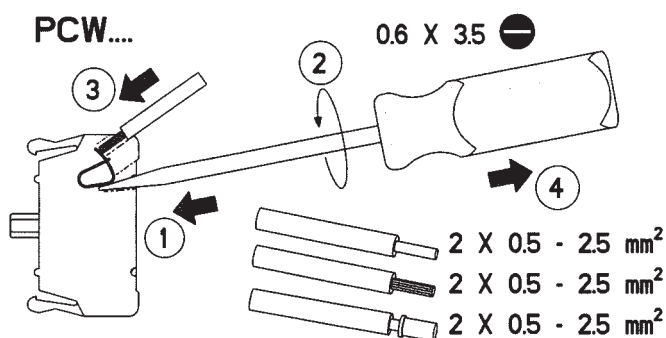
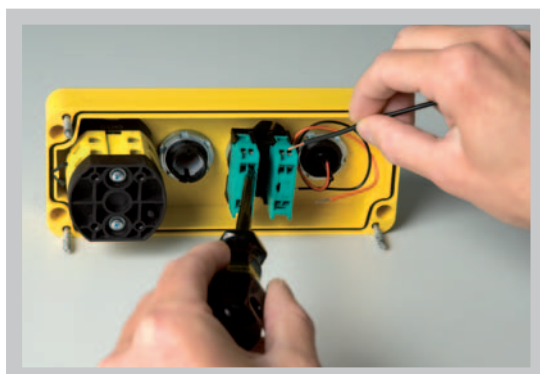





Pegasus

Contact blocks

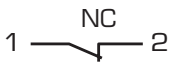
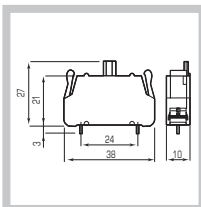
Welding terminals

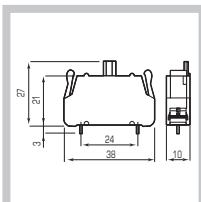
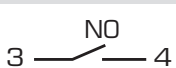
CONTACT BLOCKS

		CONTACT BLOCKS			
DESIGNATION		FUNCTIONS		CODE	DIMENSIONS
				PSC01	
				PSC10	

LAMPHOLDER BA9s

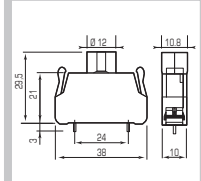
DESIGNATION	POWER SUPPLY	CODE	DIMENSIONS
	BA9s lamp socket 250V 2,4 w max bulb not included	PSCAD	

LAMPHOLDER WITH BUILT-IN LED

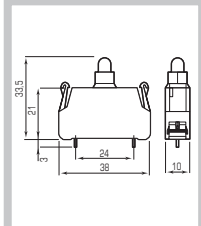
DESIGNATION	POWER SUPPLY	CODE	DIMENSIONS
	AC/DC 12V	PSC5L12	
	AC/DC 24V	PSC5L24	
	AC/DC 48V	PSC5L48	
	AC/DC 110V	PSC5L110	
	AC 220V	PSC5L220	

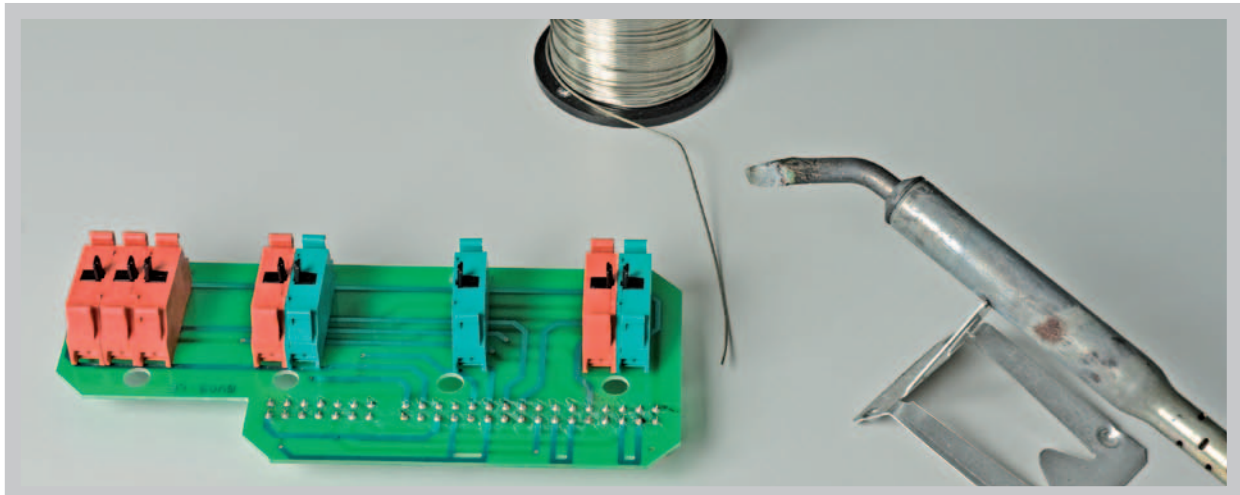

Pegasus





Contact blocks

Screw terminals



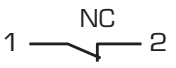

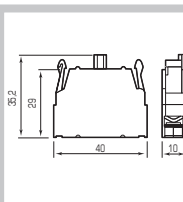
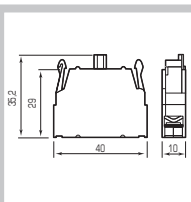
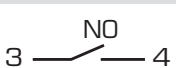
AUTOMATION TECHNOLOGIES

CONTACT BLOCKS

CONTACT BLOCKS			
DESIGNATION	FUNCTIONS	CODE	DIMENSIONS
 1  2	  	PL004001	
3  4	 	PL004002	

LAMPHOLDER BA9s

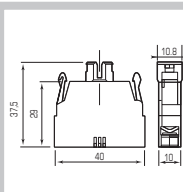
DESIGNATION	POWER SUPPLY	CODE	DIMENSIONS
 X1  X2	BA9s lamp socket 250V 2,4 w max bulb not included	PL004007	



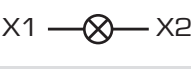
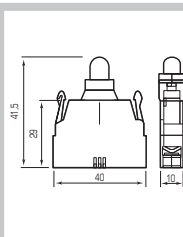



LAMPHOLDER WITH BUILT-IN LED

DESIGNATION	POWER SUPPLY	CODE	DIMENSIONS
 X1  X2	AC/DC 12V	PL0045L12	
	AC/DC 24V	PL0045L24	
	AC/DC 48V	PL0045L48	
	AC/DC 110V	PL0045L110	
	AC 220V	PL0045L220	

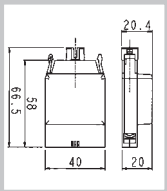
POWER SUPPLY WITH DIODE AND RESISTORS

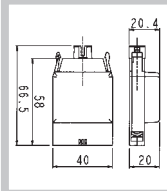
POWER SUPPLY WITH TRANSFORMER

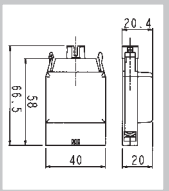
POWER SUPPLY WITH FLASHING LIGHT

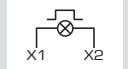











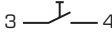
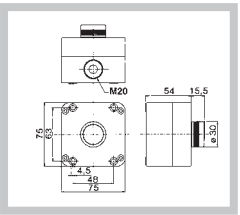

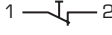

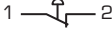
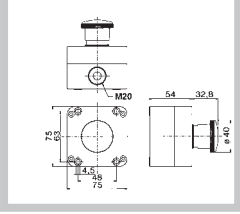



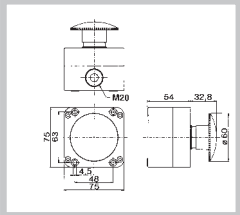



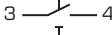

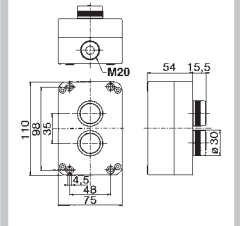

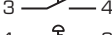

 	 	 
DESIGNATION POWER SUPPLY CODE	DESIGNATION POWER SUPPLY CODE	DESIGNATION POWER SUPPLY CODE
1 BA9s 110/130V Lamp 4B/60V -2W max  220/240V Lamp 110/130V -2W max PL004RD1 PL004RD2	1 BA9s Input 110/130V Output 24V PL004TR1 Input 220/240V Output 24V PL004TR2 Input 380/440V Output 24V  PL004TR3	1 BA9s 24V Lamp 24V-2,6 max PL004LA1 110/130V 110/130V-2,6 max PL004LA2 

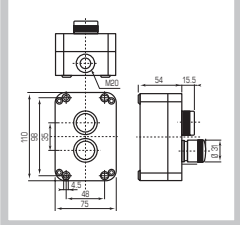
1 Lamp supply separately

Pegasus

Push button stations

IP65 □ - Screw terminal contact blocks

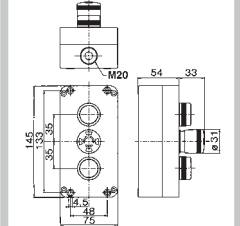
	DESCRIPTION	COL.	DESIGNATION	CODE	WEIGHT gr	MIN. PACK QTY.	DIMENSIONS
	Flush push button			PQ01RN2	176	1	
				PQ01RN1	176	1	
	Emergency stop Ø 40 not latching			PQ01M4N	192	1	
	Emergency stop Ø 60 not latching			PQ01M6N	198	1	
	With nr.2 push buttons	 	 	PQ02B	264	1	
	With nr.1 push button and nr.1 emergency EN ISO 13850	 	 	PQ02A	264	1	
	With nr.2 push button and nr.1 emergency EN ISO 13850	  	  	PQ03B	362	1	













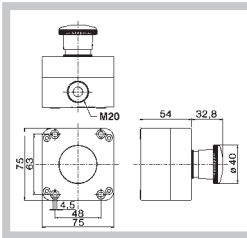

Pegasus

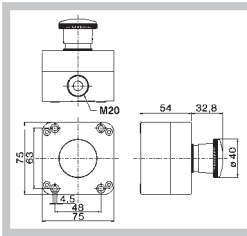
Push button stations EN ISO 13850

IP65 □ - Screw terminal contact blocks

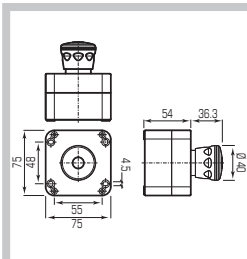

AUTOMATION TECHNOLOGIES

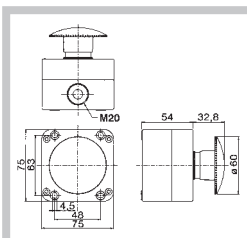
	DESCRIPTION	COL.	DESIGNATION	CODE	WEIGHT gr	MIN. PACK QTY.	DIMENSIONS
	Emergency stop \varnothing 40 twist to release	■	1  2 	PQ01R4N	190	1	
	Emergency stop \varnothing 40 push-pull	■	1  2 	PQ01P4N	192	1	
	Emergency stop pushbutton \varnothing 40 push-pull with vision	■	1  2 	PQ01P4L ¹	190	1	
	Emergency stop \varnothing 60 push-pull	■	1  2 	PQ01P6N	198	1	

NOTE TECNICHE











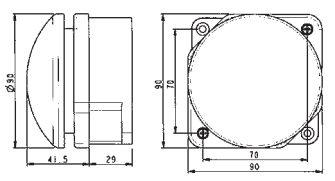

- All operators comply with the relevant European standard
- EN ISO 13850 Machine safety Emergency stop operators, functional characteristics - Design guidelines
- IEC/EN60947-5-1
- Comply with the standard IEC/EN60204-1: Machine safety Machine electrical circuits General guidelines
- The push buttons are designed with a load charge mechanism to ensure a reliable operation and stoppage, or blockage, in the activated position. The combination with positive switching NC  contacts and the presence of the "status" indicator on some models, guarantee a high degree of reliability and effectiveness.

¹ Add supply voltage code: for AC/DC 12V, 24V, 48V, 110V = L12, L24, L48, L110 ; for 220V = L220

Pegasus

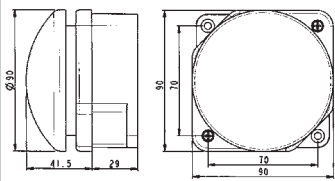
Control station with mushroom \varnothing 90

IP 66 Contact blocks spring loaded terminals

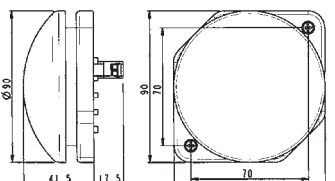
	DESCRIPTION	COLOUR	CONTACT BLOCK	CODE	DIMENSIONS
	Mushroom head momentary		.1  .2 	PG1M9W01	
	Mushroom head momentary		.3  .4	PG8M9W10	
	Mushroom head momentary flush mounting		.1  .2 	PR1M9W01	

ELECTRICAL CHARACTERISTICS

- Protectione EN60529 IP 66
- Double insulated
- Number contact capacity max.3 contact blocks
- Cable entry with 3 holes Pg 13,5/M20
- Ambient temperature: operating -25 +70°C
storage -30 +70°C
- Climate protection: IEC 68 2-3 , 2-30
- Terminals referencing: EN 50013
- Colors: Red mushroom RAL 3000,
Giovenzana yellow cover,
Black box RAL 9005,
Black mushroom RAL 3000,
Grey cover RAL 7035,
Black box RAL 3000









Pegasus

Push button station enclosures

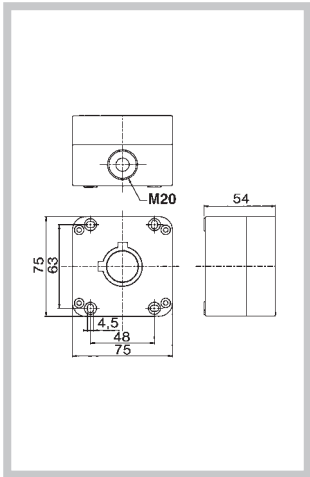
IP65  Push button station enclosures

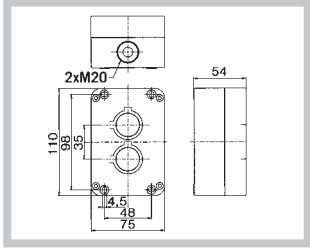

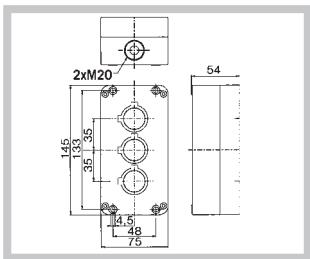
AUTOMATION TECHNOLOGIES

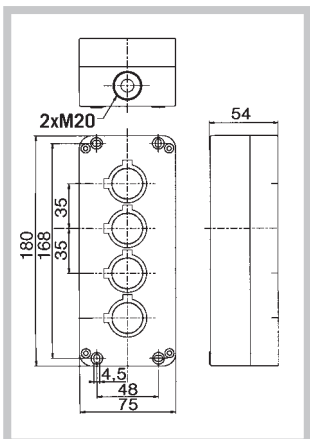
	DESCRIPTION	CODE		WEIGHT gr	MIN. PACK QTY.	DIMENSIONS
		FRONT COVER COLOUR				
	1 hole enclosure	PQ01K	-	134	1	
	1 hole enclosure	-	PQ01KGN	134	1	
	2 holes enclosure	PQ02K	PQ02KGN	174	1	
	3 holes enclosure	PQ03K	PQ03KGN	214	1	
	4 holes enclosure	PQ04K	PQ04KGN	256	1	

Pegasus

Push button station enclosures

IP65 Push button station enclosures

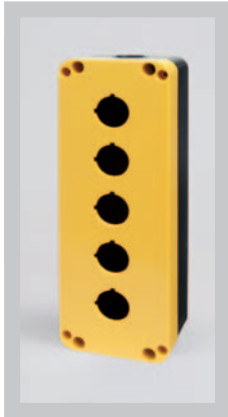
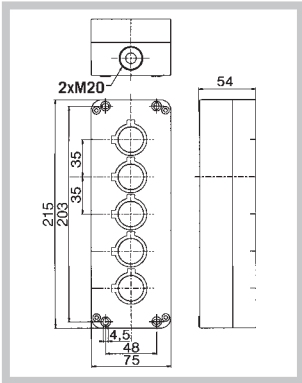
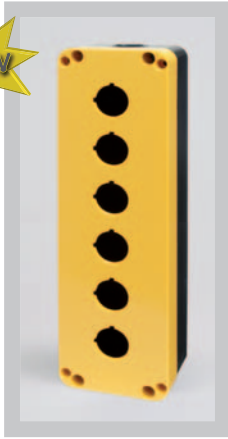
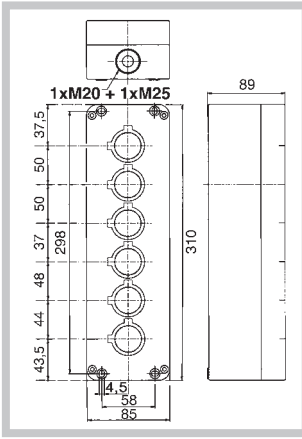
	DESCRIPTION	CODE	WEIGHT gr	MIN. PACK QTY.	DIMENSIONS
	5 holes enclosure	FRONT COVER COLOUR		296	
		PQ05K	PQ05KGN		
	6 holes enclosure	FRONT COVER COLOUR		386	
		PQ06K	PQ06KGN		

CHARACTERISTICS

ASSEMBLING

- ABS self-extinguishing material
- Self-extinguishing class VO UL94
- EN60529 IP65 protection grade
- Double insulation
- Black box RAL9005
yellow cover GGT
and grey cover RAL7035
- Threaded cable entry with membrane conduit knock:
1 hole box nr.1 M16 + 1 M20 gland,
from 2 upto 5 holes nr.2 M20 glands,
6 holes nr.1 M20 + 1 M25 glands

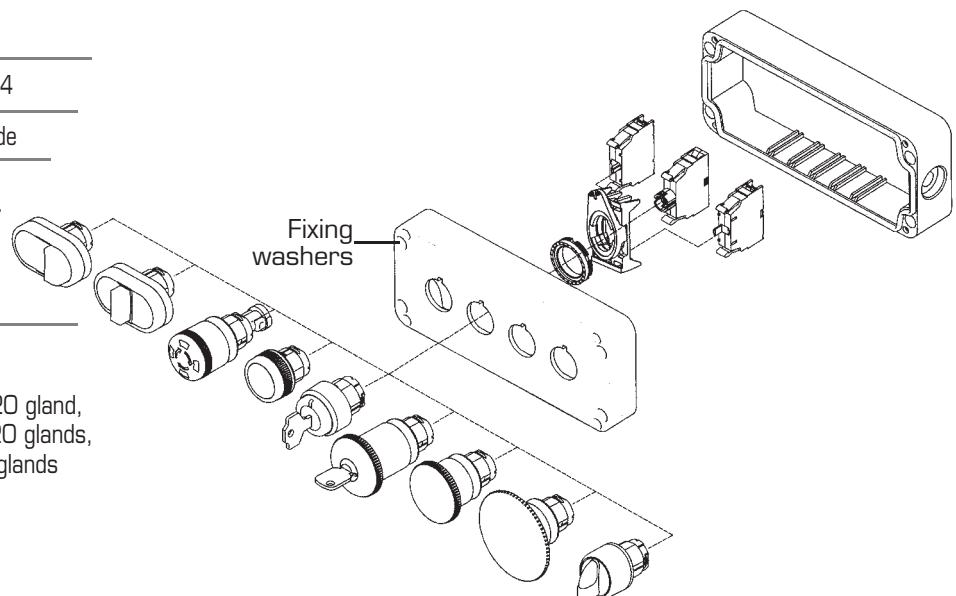

Pegasus

Control auxiliaries \varnothing 22

Pneumatic valve adapters



AUTOMATION TECHNOLOGIES

Pegasus control auxiliaries are suitable for operating certain type of pneumatic or micro valves. Push buttons can be used for such applications using a set of adapters and supports.



The operators suitable for this use are the following:

- Standard push buttons with colour cap
- Mushroom operators
- Rotary and key operators

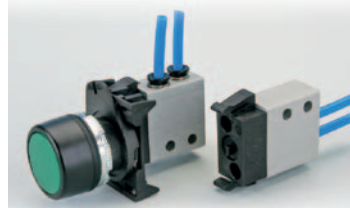

Adapters are supplied with an actuator to operate the pneumatic valve.

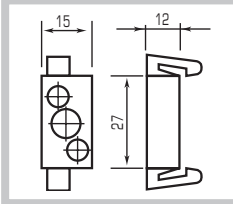

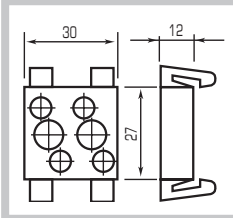
ASSEMBLY:
Operator
+Support
+Valve

	DESCRIPTION	CODE	WEIGHT gr	MIN. PACK QTY.	DIMENSIONS
	Single adapter (for 1 valve) 1	AVP1	5	10	
	Twin adapter (for 2 valves) 1	AVP2	10	10	

3/2 NC - 3/2 NO MICROVALVE - 2÷10 BAR

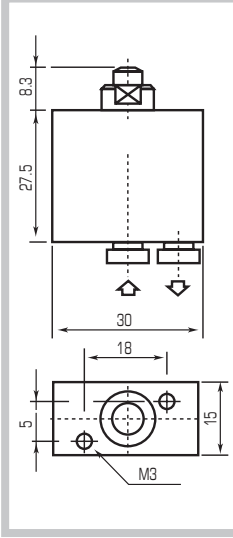
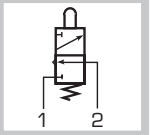
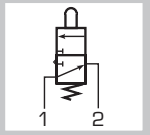
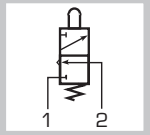
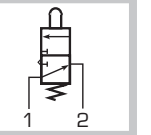
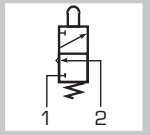
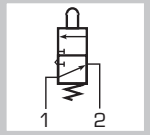
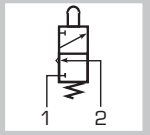
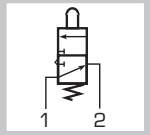
			
BOTTOM \varnothing 4 CABLE ENTRY	SIDE \varnothing 4 CABLE ENTRY	TAPPED M5 BOTTOM CABLE ENTRY	
3/2 NC 3/2 NA	3/2 NC 3/2 NA	3/2 NC 3/2 NA	
			
CODE	CODE	CODE	CODE
V304MA	V314MA	V304MAL	V314MAL
			
CODE	CODE	CODE	CODE
V305MA	V315MA		

1 Complete with actuator to operate the valve or valves/To be installed in the centre of the operator

Pegasus

Control auxiliaries ø 22

Accessories

DIN RAIL MOUNTING ADAPTOR

DIN EN50022 rail mounting for 46 mm standardised enclosures grey RAL 7035

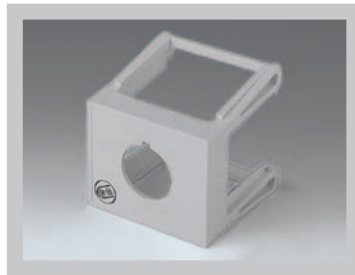

11708351

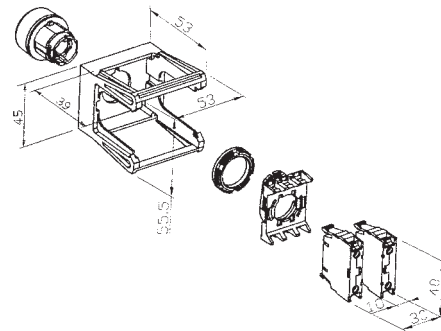

PROTECTION CAPS



FOR FLUSH PUSH BUTTON



FOR EXTENDED PUSH BUTTON



FOR MULTIFUNCTION - SERIES/TYPE

	Black line Type	CODE	Nickel line Type	CODE
Black line Series	PCR	PPDN-PPDL	PPDNNL-PPDLNL	PCDNL
Nickel line Series	PCRNL	PPMN	PPMNNL	PCMNL
		PPDNR-PPDLR	PPDNRNL-PPDLRNL	PCNNL
Black line Series	PCS			
Nickel line Series	PCSNL			

CENTRAL CONTACT OPERATION

(selectors excluded)



FOR PUSH BUTTONS STABLE-UNSTABLE
Black Line Series

PAC

KEY FIXING BULB EXTRACTOR



PCF

STOPPER CLOSING HOLES ø 22,5



PTRN8

FASTON CONNECTORS AND FOR PCB



TO SCREW CONTACTS PL.
FASTON 6,3x0,8 PCB

11708341

11708235

CONTACTS SUPPORT



TO CONTACT ELEMENTS PL., PCW, PSC. AND POWER SUPPLY

PPELN8

ON REQUEST

SPECIAL FRAMES
The auxiliary control "Nickel line" Series can be supplied with seals in different types of galvanic treatment. When ordering in different types replace the letters "NL" code with the corresponding letters of execution request: PPRN1NL becomes PPRN1SL (Sahara line)



Sahara line

SL



Grey line

GL



Copper line

RL



Pegasus

Operator caps ø 22

Buttons with symbols - Tags



AUTOMATION TECHNOLOGIES

MOMENTARY AND LATCHED, FLUSH PUSH BUTTONS



Black line

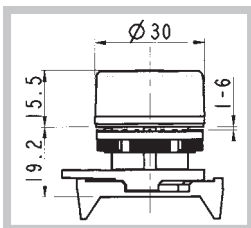

Nickel line

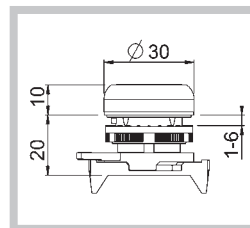

SYMBOL	COLOUR AND TYPE	CODE Black line	CODE Nickel line	SYMBOL	COLOUR AND TYPE	CODE Black line	CODE Nickel line
	GREEN	PPRN2/I	PPRN2NL/I		RED	PPRN1/OFF	PPRN1NL/OFF
	RED	PPRN1/O	PPRN1NL/O		WHITE	PPRN5/F	PPRN5NL/F
	GREEN	PPRN2/II	PPRN2NL/II		BLACK	PPRN8/F	PPRN8NL/F
	GREEN	PPRN2/START	PPRN2NL/START		GREEN	PPRN2/EIN	PPRN2NL/EIN
	RED	PPRN1/STOP	PPRN1NL/STOP		RED	PPRN1/AUS	PPRN1NL/AUS
	GREEN	PPRN2/ON	PPRN2NL/ON				

EMERGENCY STOP RING



Ø 60 Made of aluminium
Yellow background - black letters
Weight 3.5 gr
Min. packing qty. 10 pcs.

TEXT	CODE
Blank	PTE
STOP EMERGENZA	PTE/I
EMERGENCY STOP	PTE/A
NOT AUS	PTE/D

LEGEND PLATE



PPTN8



TEXT	CODE
(Blank)	PTA00
MARCIA	PTA01
ARRESTO	PTA02

LABEL

TEXT	CODE	TEXT	CODE
I O II	PTA03	EIN	PTA12
O I	PTA04	AUS	PTA13
I → O ← II	PTA17	STOP	PTA14
CHIUDE	PTA05	START	PTA15
APRE	PTA06	RESET	PTA16
EMERGENZA	PTA07	AUT O MAN	PTA18
MANUALE	PTA08	INS. - DISINS.	PTA26
AUTOMATICO	PTA09	HAND OFF AUTO	PTA27
AVANTI	PTA10	FORW OFF REV	PTA28
INDIETRO	PTA11	ON OFF	PTA29

Pegasus

Technical data

Electrical characteristics

CONTACT BLOCKS

IEC/EN 60947-5-1 CHARACTERISTICS		PLO04001 - PLO04002								PCW01-PCW10 PSC01-PSC10							
Rated insulation voltage U_i	V	690 V*								690 V*							
Rated impulse withstand voltage U_{imp}	kV	4*								4*							
Operating frequency	Hz	50/60*								50/60*							
Rated thermal current I_{th}	A	16*								16*							
Rated thermal current enclosed I_{the}	A	10*								10*							
RATED OPERATING CURRENT I_e:																	
AC15: alternate current	V	24	60	110	230	400	440	500	690	24	60	110	240	400	440	500	690
	A	16*	12	8	6	4,5	3,5	1*	1	16*	12*	5	5*	4	4	4*	2*
DC13: direct current	V	24	48	60	110	220				24	48	60	110	250			
	A	2*	1,2	0,85	0,4	0,25*				2	2*	1*	0,4	0,4*			
Conditional short circuit withstand current	A	1000*								1000*							
Fuse rating gG	500 V	10A*								10A*							
Contact insulation resistance	m Ω	<25								<25							
Switching mechanism		Slow break double gap contacts															
Contact duty		⊕ NC contact with positive opening															
Minimum tripping force		4N								4N							
Electrical life AC15	mil. cycles	1A/1,5 - 2A/0,5 - 3A/0,25								1A/1,5 - 2A/0,5 - 3A/0,25							
UL 508 CHARACTERISTICS																	
General use		10A-600V ac 2,5A-125V dc								10A-600V ac 2,5-125V dc							
Heavy Duty (HD) category		A600-Q600								A600-Q600							

LED PILOT LAMP

IEC/EN 60947-5-1 CHARACTERISTICS		LED PLML.L				BA9s - PLML.			
Rated insulation voltage U_i AC/DC	V	6 - 12 - 24 - 48 - 110 - 220				250			
Rated insulation voltage U_i AC	V	380				-			
Operating frequency	Hz	50/60				50/60			
Current I_e	mA	≤50 (6V - 12V) - ≤20 (24V...380V)				2 W max			
Brightness	cd/m ²	≤40				-			
Electrical life	h	≤30.000				-			

POWER SUPPLIES

IEC/EN 60947-5-1 CHARACTERISTICS		DIRECT PLO04007 PCWAD-PSCAD		LED PLO04.L. PCW.L.-PSC.L.		RESISTOR PLO04RD.		TRANSFORMER PLO04TR.		FLASHING LIGHT PLO04LA.	
Rated insulation voltage U_i	V	690*		400		400		440		400	
Rated operating voltage U_e	V	400* 300 ¹		AC/DC 12-24		PRIMARY	SECONDARY	PRIMARY	SECONDARY	PRIMARY	SECONDARY
	V	-		AC/DC 48		110/130	48/60	110/130	24	24	24
	V	-		AC/DC 110		220/240	110/130	220/240	24	110/130	110/130
	V	-		AC 220		-	-	380/440	24	-	-
Max rated power	W	2,4* 2,5 ¹		-		2		1,5		2,6	
Power supply		AC/DC		-		-		AC		-	
Lamp fixing system		BA9s		-		BA9s		BA9s		BA9s	

¹ UL certified values

* IMQ certified values

Pegasus

Technical data

Electrical characteristics



AUTOMATION TECHNOLOGIES

STANDARD CONFORMITY		UL, IMQ, CCC, GOST-R, R.I.NA
■ Approvals		IEC/EN60947-5-1, UL508
■ Protection class	EN60529 Black line	IP65: Buttons and switches, joysticks, single-lamp, Mushroom emergency EN ISO 13850
	EN60529 Nickel line	IP40: Multi-Function push buttons
	Conforms to UL50	IP66: Switches
	EN60529	IP67: Push buttons and multifunction push buttons
		Type 1,3R, 4, 4x,12,13, NEMA 4X
		IP65: Control stations, enclosures - IP66 mushroom pushbutton ø90
		IP20: Contacts / power PCW., PL. - IPOO; PSC.
■ Material group	EN60947-1	II
■ Pollution grade	EN60947-1	3
■ Flammability	UL94	VO: live parts
■ Ambient temperature	°C	Operating: -25 +70
	°C	Storage: -30 +70
■ Climate protection	IEC68 part 2-3	Hot damp
	IEC68 part 2-30	Unsettled hot damp
■ Terminals referencing:		EN50013
■ Terminals:		
Dimensions		A2
Screw		M3,5
Torque		1.2Nm - EN60947-1 - 12 lb.in. UL508
■ Capacity:		
solid and flexible conductors	n° 1 min/max mm ²	1/2.5 screw terminals, 0.5-2.5 spring loaded terminals
	n° 2 min/max mm ²	1/2.5 screw terminals, 0.5-2.5 spring loaded terminals
	AWG	20-12 screw terminals
■ Mechanical life:		
Mushroom operators and standard Push buttons with colour cap	mil./operations	3
Standard push buttons with lens cap		1
Latched push button with colour cap		1
Standard rotary switches		1
Rotary switches with lens, latched pushbutton with lens cap, joysticks		0.5
Emergency stop push buttons with release		0.3

Limit Switches

FA - FT - FT1R - Safety - FCT - FCM - Astra Series

Table of contents



AUTOMATION TECHNOLOGIES



Thermoplastic and die-cast aluminium limit switches



Limit switches with reset



Safety limit switches



Pre-wired thermoplastic limit switches

TABLE OF CONTENTS

■ Introduction	pag. 100	■ Installation and use	pag. 119
■ FA Series limit switches	pag. 102	■ Technical data	pag. 120
■ FT Series limit switches	pag. 108	■ FCT - FCM Series limit switches	pag. 121
■ Safety limit switches with reset	pag. 115	■ Pre-wired	
■ Safety limit switches	pag. 117	■ Astra universal limit switches	pag. 123

Limit Switches

FA - FT - FT1R - Safety - FCT - FCM - Astra Series

Terminology

DOUBLE INSULATION □

Materials of group II, according to IEC536, are made with double insulation. This consists of doubling the insulation capability by means

of an additional divider in order to eliminate any electrical shock risk and avoid the need for any additional protections.

APERTURA POSITIVA ⊕

A limit switch complies to this specification when all the normally closed contact elements of the switch can be changed, with certainty, to the open position (no flexible link between the moving contacts and the operator of the switch, to which an actuating force is applied). Positive opening does not apply to NO contacts. Control switches

with positive opening operation can be equipped with either slow-break or snap-action contacts. In order to use different contacts on the same switch, it is necessary to electrically separate them; otherwise only one contact can be used. Every positive opening control switch must be marked on the external housing with the symbol. ⊕

CONTACT ELEMENTS ACTING INDEPENDENTLY (OR SNAP ACTION)

Is defined, under IEC947-5-1/EN6094-5-1, the contact element of a device for manual or automatic control circuits where the speed of motion of the contact is virtually independent of the speed of motion of the actuator. Commonly called "quick trigger" the electrical behavior of these elements means that the contact is in order even in the slow movements of the actuator. These contact elements have position does not coincide with the release of drive (differential stroke) See example page. 105.

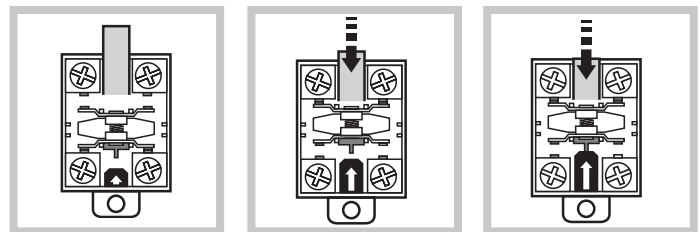

Contatto a riposo

Contatto azionato

Apertura positiva

CONTACT ELEMENTS DIRECT ACTING (OR SLOW ACTION)

Is defined, under IEC947-5-1/EN6094-5-1, the contact element of a device for manual or automatic control circuits where speed of movement of the contact depends on the speed of motion of the actuator. See example page. 105

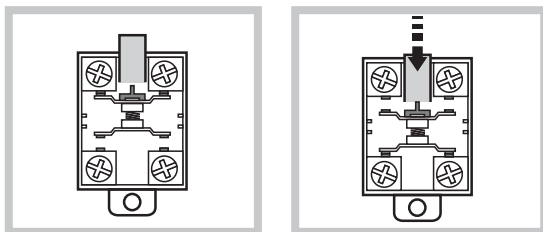

Contact in stand-by

Contact activated

CONTACT BLOCKS CONFIGURATION

ACCORDING TO IEC/EN60947-5-1

Contact blocks with 4 terminals must be marked with Za or Zb symbols as shown in the picture below.

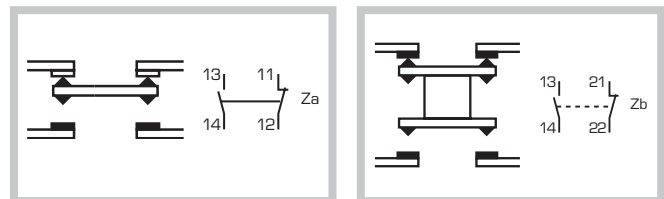

Contacts with same polarity

The two moving contacts are electrically insulated

APPLICATIONS

AC-15: control of an electromagnet on a.c., test 10 le/le.

AC-13: control of an electromagnet on d.c., test le/le.

TERMINALS

For limit switches with metal housing, the fixing point of the earth conductor must be marked and must be positioned inside the housing next to the cable entry.

Limit Switches

FA - FT - FT1R - Safety - FCT - FCM - Astra Series
Terminology



AUTOMATION TECHNOLOGIES

MINIMUM OPENING FORCE/MOMENTUM

It is the minimum force/momentum that must be applied by the actuator for the contacts to trip.

MINIMUM POSITIVE OPENING FORCE/MOMENTUM

It is the minimum force/momentum that must be applied by the actuator to guarantee the positive opening of NC contacts.

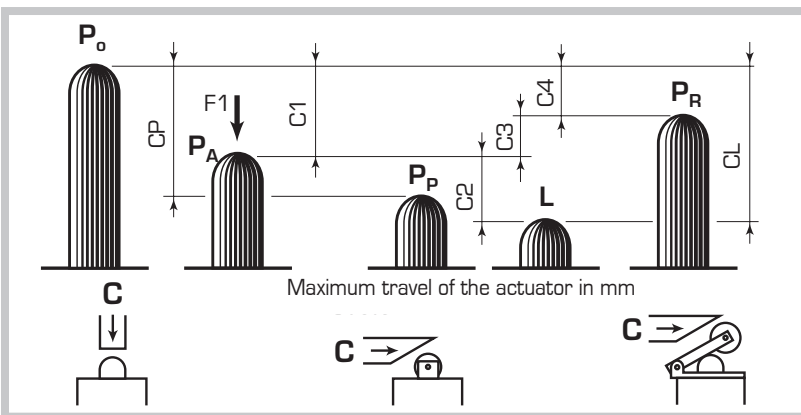

- P_o** Rest position
Position of the actuator when no external force is applied.
- P_A** Tripping point of contact
Position of the actuator, with force F1 applied, in which the contacts leave the stand-by position.
- P_p** Positive opening position
Position of the actuator when there is positive opening.
- L** Maximum travel position
Maximum travel of the actuator when the force F1 is applied.
- P_R** Resetting position
Position of the actuator when the contacts are back in their non actuated position.

- C₁** Tripping travel
Distance between the P_o and P_A positions.
- C_p** Positive opening tripping travel
Minimum travel of the actuator from the P_o position to guarantee positive opening of NC contacts.
- C₂** Extra tripping travel
Distance between P_A and the maximum travel L.
- C₁** Maximum travel
Distance between P_o and the maximum travel L.
- C₃** Differential travel (C₁-C₄)
Distance between P_A and P_R
- C₄** Resetting travel
Distance between P_R and P_o

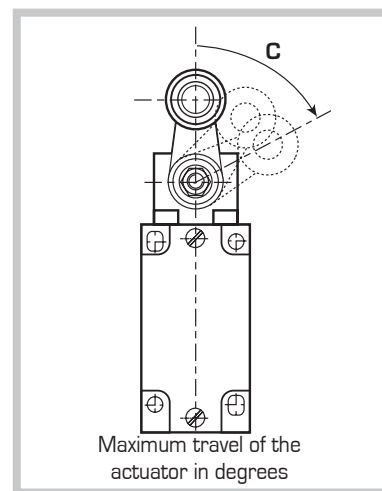

Maximum travel of the actuator in degrees
Tripping travel for snap-action contacts

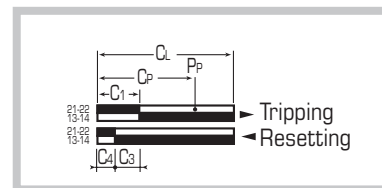

Tripping travel for slow-break contacts

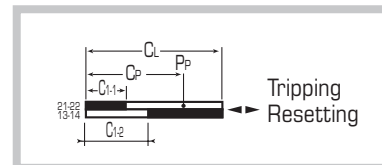

NOTE: for slow-break contacts, C3=01, C1-1=Tripping and resetting travel of contacts 21-22, C1-2= Tripping and resetting travel of contacts 13-14

Examples

FA134Z11
(snap-action contacts)



Tripping travel in mm/
cam linear movement

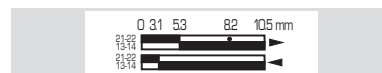

FA138Z11
(snap-action contacts)

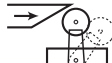

Tripping travel in degrees/
lever rotary movement



FA131X11
(slow break contacts)



Tripping travel in mm/
plunger linear movement



Limit Switches

FA1 Series

IP66 die-cast aluminium type

1 cable entry
M16x1.5



FA131



FA134



FA132



FA133

TYPE OF OPERATOR	SHORT STEEL END PLUNGER	STEEL ROLLER PLUNGER	ROLLER LEVER PLUNGER HORIZONTAL ACTUATION	ROLLER LEVER PLUNGER VERTICAL ACTUATION
Standard - Positive opening NC contacts	EN50047	EN50047	-	-
Minimum tripping force	15	12	7	7
Minimum positive opening force	30	30	24	24
Z11 1NC-1NO Snap action Zb	FA131Z11 0 13 25 41 56 mm	FA134Z11 0 25 47 76 96 mm	FA132Z11 0 49 90 145 210 mm	FA133Z11 0 49 90 145 210 mm
X11 1NC-1NO Slow break Zb	FA131X11 0 16 32 56 mm 2.5	FA134X11 0 32 60 96 mm 46	FA132X11 0 60 105 210 mm 86	FA133X11 0 60 105 210 mm 86
Y11 1NC-1NO Slow break overlapping Zb	FA131Y11 0 29 45 56 mm 15	FA134Y11 0 53 82 96 mm 30	FA132Y11 0 102 146 210 mm 54	FA133Y11 0 102 146 210 mm 54
Z02 2NC Snap action Zb	FA131Z02 0 13 24 40 56 mm	FA134Z02 0 25 45 74 96 mm	FA132Z02 0 51 86 131 210 mm	FA133Z02 0 51 86 131 210 mm
W02 2NC Slow break Zb	FA131W02 0 15 31 56 mm	FA134W02 0 30 59 96 mm	FA132W02 0 57 102 210 mm	FA133W02 0 57 102 210 mm
W20 2NO Slow break Zb	FA131W20 0 14 56 mm	FA134W20 0 28 96 mm	FA132W20 0 5.3 210 mm	FA133W20 0 5.3 210 mm
WEIGHT gr - MIN. PACK QTY.	168 gr 1 pcs	175 gr 1 pcs	186 gr 1 pcs	186 gr 1 pcs

DIMENSIONS

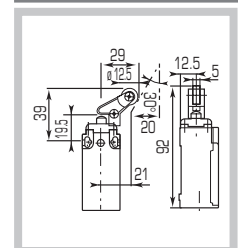
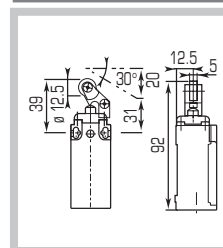
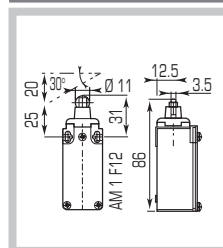
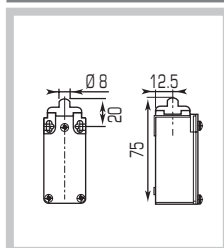
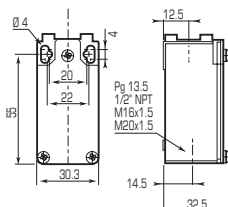

Limit Switches

FA1 Series

IP66 die-cast aluminium type



AUTOMATION TECHNOLOGIES

1 cable entry
M16x1.5



FA138



FA141



FA139



FA140

TYPE OF OPERATOR	ROLLER LEVER Ø 18	RUBBER ROLLER LEVER Ø 50	VARIABLE LENGTH ROLLER LEVER Ø 18	VARIABLE LENGTH RUBBER ROLLER LEVER Ø 50
Standard - Positive opening NC contacts	-	-	-	-
Minimum tripping force	0.10	0.10	0.10	0.10
Minimum positive opening force	0.32	-	-	-
Z11 1NC-1NO Zb	FA138Z11 	FA141Z11 	FA139Z11 	FA140Z11
X11 1NC-1NO Zb	FA138X11 	FA141X11 	FA139X11 	FA140X11
Y11 1NC-1NO overlapping Zb	FA138Y11 	FA141Y11 	FA139Y11 	FA140Y11
Z02 2NC Zb	FA138Z02 	FA141Z02 	FA139Z02 	FA140Z02
W02 2NC Zb	FA138W02 	FA141W02 	FA139W02 	FA140W02
W20 2NO Zb	FA138W20 	FA141W20 	FA139W20 	FA140W20

WEIGHT gr - MIN. PACK QTY.

235 gr 1 pcs 255 gr 1 pcs 245 gr 1 pcs 265 gr 1 pcs

DIMENSIONS

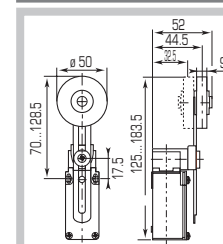
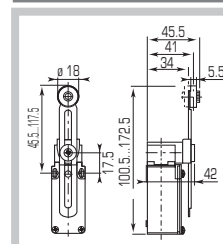
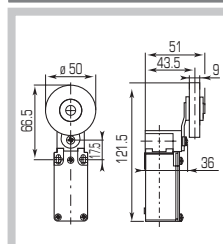
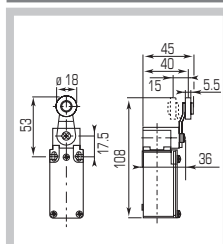
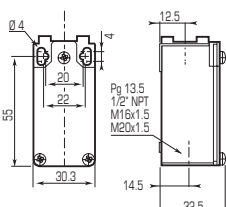

Limit Switches

FA1 Series

IP66 die-cast aluminium type

1 cable entry
M16x1.5



FA135



FA136



FA137

TYPE OF OPERATOR	SPRING LEVER WITH TIP IN PA	"CAT'S WHISKER"	STEEL ROD LEVER Ø 3
Standard - Positive opening NC contacts	-	-	-
Minimum tripping force	0.10	0.10	0.10
Minimum positive opening force	-	-	-
Z11 1NC-1NO Snap action Zb	FA135Z11 	FA136Z11 	FA137Z11
X11 1NC-1NO Slow break Zb	FA135X11 	FA136X11 	FA137X11
Y11 1NC-1NO Slow break overlapping Zb	FA135Y11 	FA136Y11 	FA137Y11
Z02 2NC Snap action Zb	FA135Z02 	FA136Z02 	FA137Z02
W02 2NC Slow break Zb	FA135W02 	FA136W02 	FA137W02
W20 2NO Slow break Zb	FA135W20 	FA136W20 	FA137W20

WEIGHT gr - MIN. PACK QTY.

235 gr 1 pcs

255 gr 1 pcs

245 gr 1 pcs

DIMENSIONS

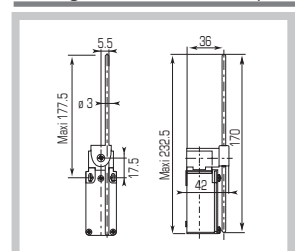
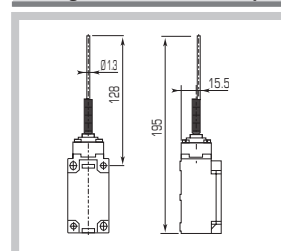
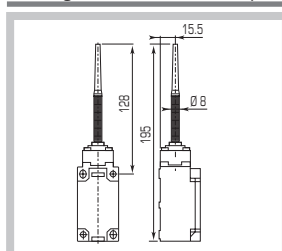
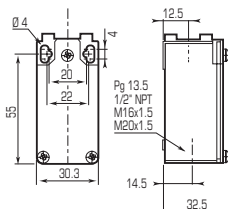

Limit Switches

FA3 Series

IP66 die-cast aluminium type



AUTOMATION TECHNOLOGIES

3 cable entries
M16x1.5



FA331



FA334



FA332

TYPE OF OPERATOR	SHORT STEEL END PLUNGER	SHORT STEEL ROLLER PLUNGER	ROLLER LEVER PLUNGER HORIZONTAL ACTUATION
Standard - Positive opening NC contacts	-	-	-
Minimum tripping force	15	12	7
Minimum positive opening force	30	30	24
Z11 1NC-1NO Snap action Zb	FA331Z11 	FA334Z11 	FA332Z11
X11 1NC-1NO Slow break Zb	FA331X11 	FA334X11 	FA332X11
Y11 1NC-1NO Slow break overlapping Zb	FA331Y11 	FA334Y11 	FA332Y11
Z02 2NC Snap action Zb	FA331Z02 	FA334Z02 	FA332Z02
W02 2NC Slow break Zb	FA331W02 	FA334W02 	FA332W02
W20 2NO Slow break Zb	FA331W20 	FA334W20 	FA332W20

WEIGHT gr - MIN. PACK QTY.

270 gr 1 pcs 280 gr 1 pcs 290 gr 1 pcs

DIMENSIONS

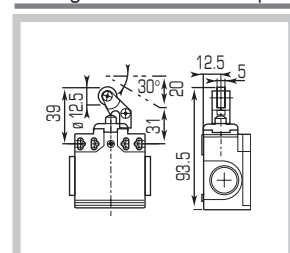
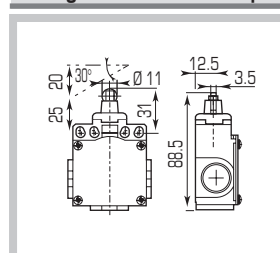
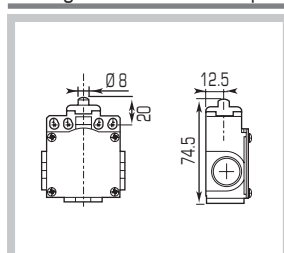
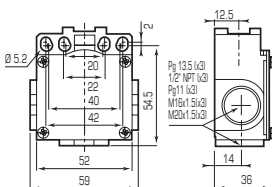

Limit Switches

FA3 Series

IP66 die-cast aluminium type

3 cable entries
M16x1.5



FA338

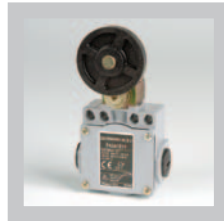

FA341

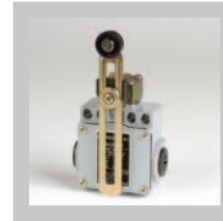

FA339



FA340

TYPE OF OPERATOR	ROLLER LEVER Ø 18	RUBBER ROLLER LEVER Ø 50	VARIABLE LENGTH ROLLER LEVER Ø 18	VARIABLE LENGTH RUBBER ROLLER LEVER Ø 50
Standard - Positive opening NC contacts	-	-	-	-
Minimum tripping force	0.10	0.10	0.10	0.10
Minimum positive opening force	0.32	-	-	-
Z11 1NC-1NO Snap action Zb	FA338Z11 	FA341Z11 	FA339Z11 	FA340Z11
X11 1NC-1NO Slow break Zb	FA338X11 	FA341X11 	FA339X11 	FA340X11
Y11 1NC-1NO Slow break overlapping Zb	FA338Y11 	FA341Y11 	FA339Y11 	FA340Y11
Z02 2NC Snap action Zb	FA338Z02 	FA341Z02 	FA339Z02 	FA340Z02
W02 2NC Slow break Zb	FA338W02 	FA341W02 	FA339W02 	FA340W02
W20 2NO Slow break Zb	FA338W20 	FA341W20 	FA339W20 	FA340W20

WEIGHT gr - MIN. PACK QTY.

325 gr 1 pcs 345 gr 1 pcs 335 gr 1 pcs 355 gr 1 pz

DIMENSIONS

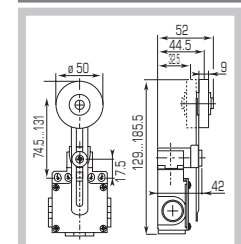
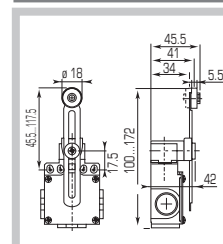
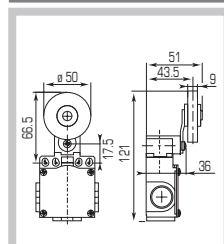
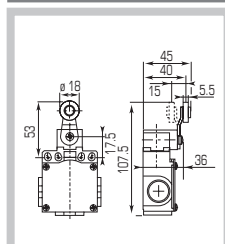
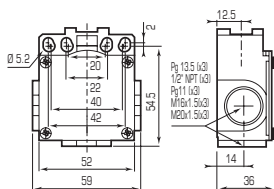

Limit Switches

FA3 Series

IP66 die-cast aluminium type



AUTOMATION TECHNOLOGIES

3 cable entries
M16x1.5



FA335



FA336



FA337

TYPE OF OPERATOR	SPRING LEVER WITH TIP IN PA	"CAT'S WHISKER"	VARIABLE LENGTH STEEL ROD LEVER Ø 3
Standard - Positive opening NC contacts	-	-	-
Minimum tripping force	0.10	0.10	0.10
Minimum positive opening force	-	-	-
Z11 1NC-1NO Snap action Zb	FA335Z11 	FA336Z11 	FA337Z11
X11 1NC-1NO Slow break Zb	FA335X11 	FA336X11 	FA337X11
Y11 1NC-1NO Slow break overlapping Zb	FA335Y11 	FA336Y11 	FA337Y11
Z02 2NC Snap action Zb	FA335Z02 	FA336Z02 	FA337Z02
W02 2NC Slow break Zb	FA335W02 	FA336W02 	FA337W02
W20 2NO Slow break Zb	FA335W20 	FA336W20 	FA337W20

WEIGHT gr - MIN. PACK QTY.

305 gr 1 pcs

320 gr 1 pcs

380 gr 1 pcs

DIMENSIONS

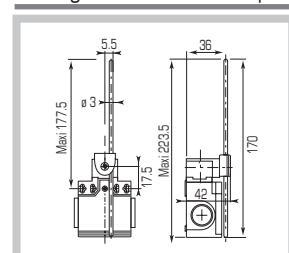
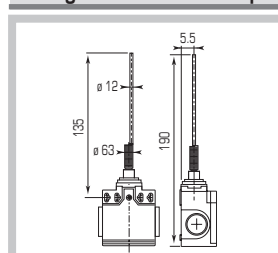
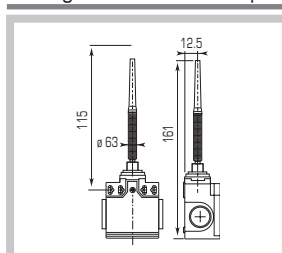
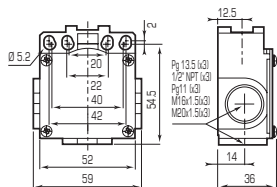

Limit Switches

FT1 Series

IP65 □ thermoplastic type

1 cable entry
M16x1.5



FT131



FT1P31



FT134



FT132

TYPE OF OPERATOR	SHORT STEEL END PLUNGER	SHORT STEEL END PLUNGER WITH PROTECTIVE BOOT	ROLLER LEVER PLUNGER	ROLLER LEVER PLUNGER HORIZONTAL ACTUATION
Standard - Positive opening NC contacts	EN50047	EN50047	EN50047	EN50047
Minimum tripping force	15	15	12	7
Minimum positive opening force	30	30	30	24
Z11 Snap action 1NC-1NO Zb	FT131Z11 	FT1P31Z11 	FT134Z11 	FT132Z11
X11 Slow break 1NC-1NO Zb	FT131X11 	FT1P31X11 	FT134X11 	FT132X11
Y11 Slow break 1NC-1NO overlapping Zb	FT131Y11 	FT1P31Y11 	FT134Y11 	FT132Y11
Z02 Snap action 2NC Zb	FT131Z02 	FT1P31Z02 	FT134Z02 	FT132Z02
W02 Slow break 2NC Zb	FT131W02 	FT1P31W02 	FT134W02 	FT132W02
W20 Slow break 2NO Zb	FT131W20 	FT1P31W20 	FT134W20 	FT132W20

WEIGHT gr - MIN. PACK QTY.

60 gr 1 pcs

60 gr 1 pcs

62 gr 1 pcs

65 gr 1 pcs

DIMENSIONS

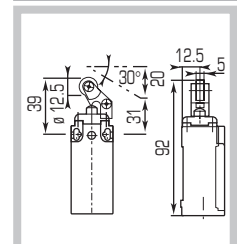
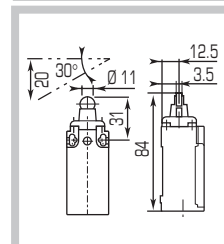
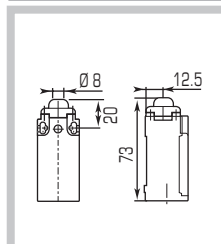
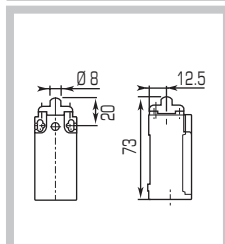
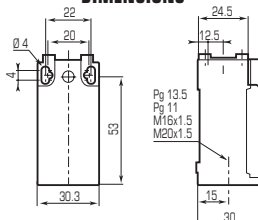

Limit Switches

FT1 Series

IP65 □ thermoplastic type



AUTOMATION TECHNOLOGIES

1 cable entry
M16x1.5



FT1P32



FT133



FT1P33



FT138

TYPE OF OPERATOR	ROLLER LEVER PLUNGER WITH PROTECTIVE BOOT HORIZONTAL ACTUATION	ROLLER LEVER PLUNGER VERTICAL ACTUATION	ROLLER LEVER PLUNGER WITH PROTECTIVE BOOT VERTICAL ACTUATION	ROLLER LEVER Ø 18
Standard - Positive opening NC contacts (→)	EN50047 (→)	EN50047 (→)	EN50047 (→)	EN50047 (→)
Minimum tripping force	N	7	7	0.10
Minimum positive opening force	N	24	24	0.32
Z11 Snap action 1NC-1NO	FT1P32Z11 0 49 90 145 210 mm	FT133Z11 0 49 90 145 210 mm	FT1P33Z11 0 49 90 145 210 mm	FT138Z11 0 17Y 31Y 47Y 74Y
X11 Slow break 1NC-1NO	FT1P32X11 0 60 105 210 mm 86	FT133X11 0 60 105 210 mm 86	FT1P33X11 0 60 105 210 mm 86	FT138X11 0 21Y 37Y 74Y 30Y
Y11 Slow break 1NC-1NO overlapping	FT1P32Y11 0 102 146 210 mm 54	FT133Y11 0 102 146 210 mm 54	FT1P33Y11 0 102 146 210 mm 54	FT138Y11 0 35° 51° 74° 18°
Z02 Snap action 2NC	FT1P32Z02 0 51 86 131 210 mm	FT133Z02 0 51 86 131 210 mm	FT1P33Z02 0 51 86 131 210 mm	FT138Z02 0 17 30 46 74
W02 Slow break 2NC	FT1P32W02 0 57 102 210 mm	FT133W02 0 57 102 210 mm	FT1P33W02 0 57 102 210 mm	FT138W02 0 19 37 74
W20 Slow break 2NO	FT1P32W20 0 5.3 210 mm	FT133W20 0 5.3 210 mm	FT1P33W20 0 5.3 210 mm	FT138W20 0 18Y 74Y

WEIGHT gr - MIN. PACK QTY.

65 gr 1 pcs 65 gr 1 pcs 65 gr 1 pcs 80 gr 1 pcs

DIMENSIONS

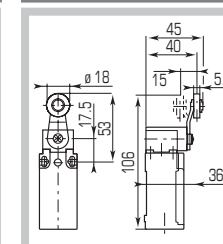
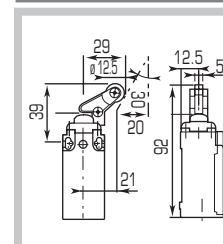
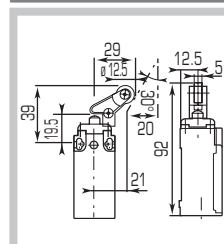
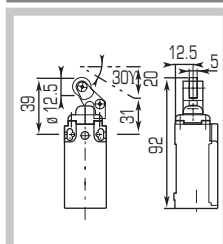
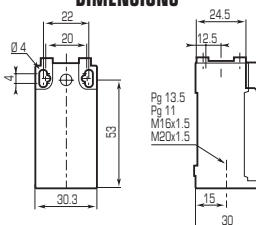

Limit Switches

FT1 Series

IP65 □ thermoplastic type

1 cable entry
M16x1.5



FT141



FT139

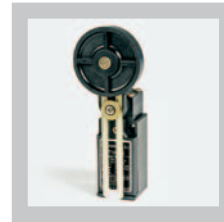

FT140

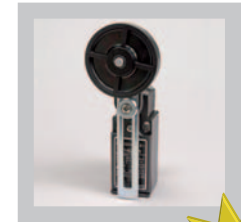

FT140R



TYPE OF OPERATOR	RUBBER ROLLER LEVER Ø 50	VARIABLE LENGTH ROLLER LEVER Ø 18	VARIABLE LENGTH RUBBER ROLLER LEVER Ø 50	VARIABLE LENGTH AND RUBBER ROLLER LEVER Ø 50
Standard - Positive opening NC contacts	-	-	-	-
Minimum tripping force	N	0.10	0.10	0.10
Minimum positive opening force	N	-	-	-
Z11 Snap action 1NC-1NO	FT141Z11 	FT139Z11 	FT140Z11 	FT140Z11R
X11 Slow break 1NC-1NO	FT141X11 	FT139X11 	FT140X11 	FT140X11R
Y11 Slow break 1NC-1NO overlapping	FT141Y11 	FT139Y11 	FT140Y11 	FT140Y11R
Z02 Snap action 2NC	FT141Z02 	FT139Z02 	FT140Z02 	FT140Z02R
W02 Slow break 2NC	FT141W02 	FT139W02 	FT140W02 	FT140W02R
W20 Slow break 2NO	FT141W20 	FT139W20 	FT140W20 	FT140W20R

WEIGHT gr - MIN. PACK QTY.

95 gr 1 pcs

105 gr 1 pcs

125 gr 1 pcs

125 gr 1 pcs

DIMENSIONS

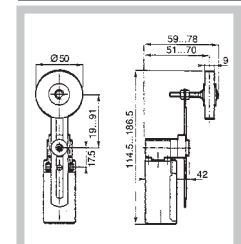
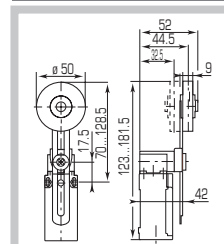
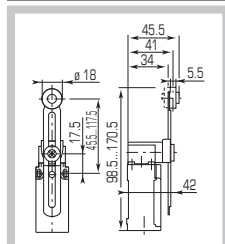
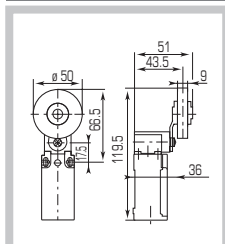
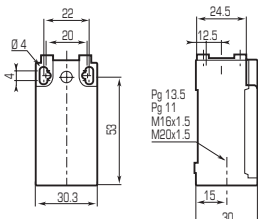

Limit Switches

FT1 Series

IP65 thermoplastic type



AUTOMATION TECHNOLOGIES

1 cable entry
M16x1.5



FT135



FT136



FT137

TYPE OF OPERATOR	SPRING LEVER WITH TIP IN PA	"CAT'S WHISKER"	VARIABLE LENGTH STEEL ROD LEVER Ø 3
Standard - Positive opening NC contacts	EN50047	-	-
Minimum tripping force	0.12	0.12	0.12
Minimum positive opening force	-	-	-
Z11 Snap action 1NC-1NO	FT135Z11 	FT136Z11 	FT137Z11
X11 Slow break 1NC-1NO	FT135X11 	FT136X11 	FT137X11
Y11 Slow break 1NC-1NO overlapping	FT135Y11 	FT136Y11 	FT137Y11
Z02 Snap action 2NC	FT135Z02 	FT136Z02 	FT137Z02
W02 Slow break 2NC	FT135W02 	FT136W02 	FT137W02
W20 Slow break 2NO	FT135W20 	FT136W20 	FT137W20

WEIGHT gr - MIN. PACK QTY.

70 gr 1 pcs

80 gr 1 pcs

105 gr 1 pcs

DIMENSIONS

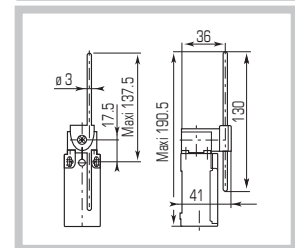
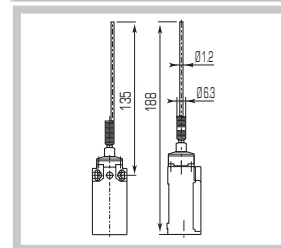
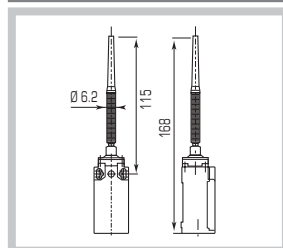
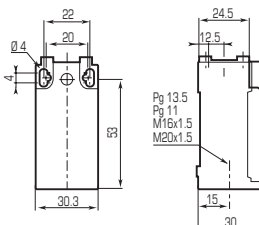

Limit Switches

FT2 Series

IP65 □ thermoplastic type

2 cable entry
M16x1.5



FT231



FT2P31



FT234



FT232

TYPE OF OPERATOR	SHORT STEEL END PLUNGE	SHORT STEEL END PLUNGER WITH PROTECTIVE BOOT	ROLLER LEVER PLUNGER	ROLLER LEVER PLUNGER HORIZONTAL ACTUATION
Standard - Positive opening NC contacts (→)	- (→)	- (→)	- (→)	- (→)
Minimum tripping force N	15	15	12	7
Minimum positive opening force N	30	30	30	24
Z11 Snap action 1NC-1NO	FT231Z11 0 13 25 41 56 mm	FT2P31Z11 0 13 25 41 56 mm	FT234Z11 0 25 47 76 96 mm	FT232Z11 0 49 90 145 210 mm
X11 Slow break 1NC-1NO	FT231X11 0 16 32 56 mm 2.5	FT2P31X11 0 16 32 56 mm 2.5	FT234X11 0 32 60 96 mm 46	FT232X11 0 60 105 210 mm 86
Y11 Slow break 1NC-1NO overlapping	FT231Y11 0 29 45 56 mm 1.5	FT2P31Y11 0 29 45 56 mm 1.5	FT234Y11 0 53 82 96 mm 30	FT232Y11 0 102 146 210 mm 54
Z02 Snap action 2NC	FT231Z02 0 13 24 40 56 mm	FT2P31Z02 0 13 24 40 56 mm	FT234Z02 0 25 45 74 96 mm	FT232Z02 0 51 86 131 210 mm
W02 Slow break 2NC	FT231W02 0 15 31 56 mm	FT2P31W02 0 15 31 56 mm	FT234W02 0 30 59 96 mm	FT232W02 0 57 102 210 mm
W20 Slow break 2NO	FT231W20 0 14 56 mm	FT2P31W20 0 14 56 mm	FT234W20 0 28 96 mm	FT232W20 0 5.3 210 mm

WEIGHT gr - MIN. PACK QTY.

100 gr 1 pcs

100 gr 1 pcs

105 gr 1 pcs

105 gr 1 pcs

DIMENSIONS

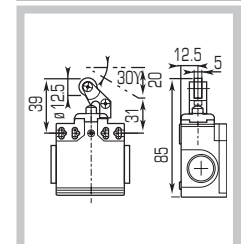
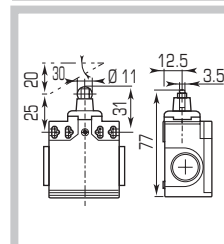
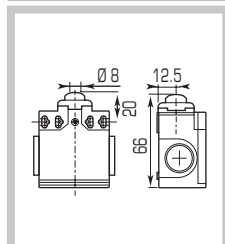
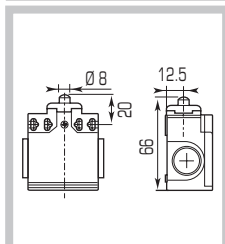
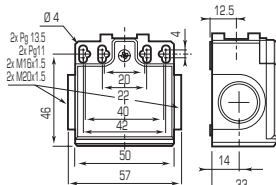

Limit Switches

FT2 Series

IP65 □ thermoplastic type



AUTOMATION TECHNOLOGIES

2 cable entry
M16x1.5



FT2P32



FT238



FT239



FT240

TYPE OF OPERATOR	ROLLER LEVER PLUNGER WITH PROTECTIVE BOOT HORIZONTAL ACTUATION	ROLLER LEVER Ø 18	VARIABLE LENGTH ROLLER LEVER Ø 18	VARIABLE LENGTH Ø 50 RUBBER ROLLER LEVER
Standard - Positive opening NC contacts	-	-	-	-
Minimum tripping force N	7	0.10	0.10	0.10
Minimum positive opening force N	24	0.32	-	-
Z11 Snap action 1NC-1NO	FT2P32Z11 	FT238Z11 	FT239Z11 	FT240Z11
X11 Slow break 1NC-1NO	FT2P32X11 	FT238X11 	FT239X11 	FT240X11
Y11 Slow break 1NC-1NO overlapping	FT2P32Y11 	FT238Y11 	FT239Y11 	FT240Y11
Z02 Snap action 2NC	FT2P32Z02 	FT238Z02 	FT239Z02 	FT240Z02
W02 Slow break 2NC	FT2P32W02 	FT238W02 	FT239W02 	FT240W02
W20 Slow break 2NO	FT2P32W20 	FT238W20 	FT239W20 	FT240W20

WEIGHT gr - MIN. PACK QTY.

105 gr 1 pcs 125 gr 1 pcs 125 gr 1 pcs 155 gr 1 pcs

DIMENSIONS

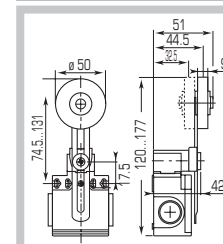
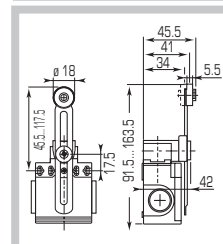
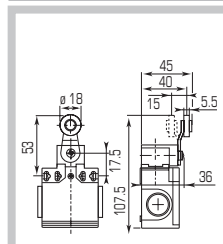
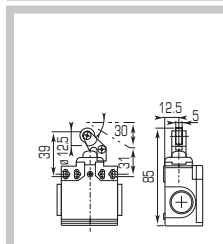
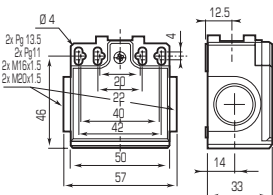

Limit Switches

Serie FT2

IP65 □ thermoplastic type

2 cable entries
M16x1.5



FT241



FT235



FT236



FT237

TYPE OF OPERATOR	Ø 50 RUBBER ROLLER LEVER	SPRING LEVER WITH TIP IN PA	"CAT'S WHISKER"	VARIABLE LENGTH Ø 3 STEEL ROD LEVER
Standard - Positive opening NC contacts	-	-	-	-
Minimum tripping force N	0.10	0.10	0.10	0.10
Minimum positive opening force N	-	0.32	-	-
Z11 Snap action 1NC-1NO	FT241Z11 	FT235Z11 	FT236Z11 	FT237Z11
X11 Slow break 1NC-1NO	FT241X11 	FT235X11 	FT236X11 	FT237X11
Y11 Slow break 1NC-1NO overlapping	FT241ZY11 	FT235Y11 	FT236Y11 	FT237Y11
Z02 Snap action 2NC	FT241Z02 	FT235Z02 	FT236Z02 	FT237Z02
W02 Slow break 2NC	FT241W02 	FT235W02 	FT236W02 	FT237W02
W20 Slow break 2NO	FT241W20 	FT235W20 	FT236W20 	FT237W20
WEIGHT gr - MIN. PACK QTY.	145 gr 1 pcs	135 gr 1 pcs	110 gr 1 pcs	130 gr 1 pcs

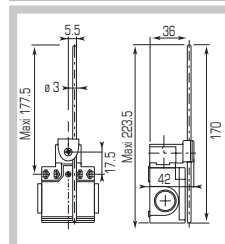
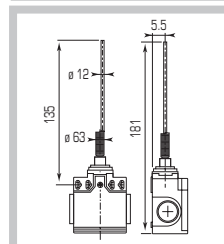
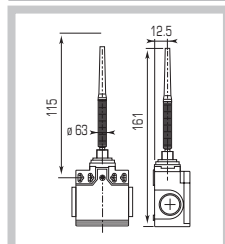
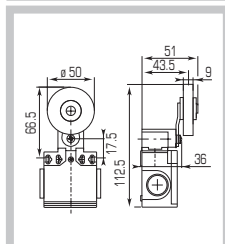
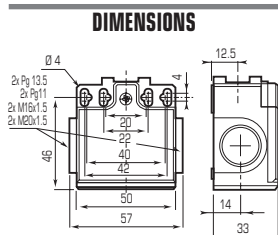

Limit Switches

FT1R Series with reset

IP65 □ thermoplastic type



AUTOMATION TECHNOLOGIES

1 cable entry
M16x1.5



FT1R31



FT1R34



FT1R32



FT1R33

TYPE OF OPERATOR	SHORT STEEL END PLUNGER	PA ROLLER PLUNGER	PA ROLLER LEVER PLUNGER HORIZONTAL ACTUATION	PA ROLLER LEVER PLUNGER VERTICAL ACTUATION
Standard - Positive opening NC contacts (→)	- (→)	- (→)	- (→)	- (→)
Minimum tripping force N	15	12	7	7
Minimum positive opening force N	30	30	24	24
Z11 Snap action 1NC-1NO	FT1R31Z11 0 13 25 41 56 mm	FT1R34Z11 0 25 47 76 96 mm	FT1R32Z11 0 49 90 145 210 mm	FT1R33Z11 0 49 90 145 210 mm
X11 Slow break 1NC-1NO	FT1R31X11 0 16 32 56 mm 2.5	FT1R34X11 0 32 60 96 mm 46	FT1R32X11 0 60 105 210 mm 86	FT1R33X11 0 60 105 210 mm 86
Y11 Slow break 1NC-1NO overlapping	FT1R31Y11 0 29 45 56 mm 15	FT1R34Y11 0 53 82 96 mm 30	FT1R32Y11 0 102 146 210 mm 54	FT1R33Y11 0 102 146 210 mm 54
Z02 Snap action 2NC	FT1R31Z02 0 13 24 40 56 mm	FT1R34Z02 0 25 45 74 96 mm	FT1R32Z02 0 51 86 131 210 mm	FT1R33Z02 0 51 86 131 210 mm
W02 Slow break 2NC	FT1R31W02 0 15 31 56 mm	FT1R34W02 0 30 59 96 mm	FT1R32W02 0 57 102 210 mm	FT1R33W02 0 57 102 210 mm

WEIGHT gr - MIN. PACK QTY.

75 gr

1 pcs

78 gr

1 pcs

80 gr

1 pcs

80 gr

1 pcs

DIMENSIONS

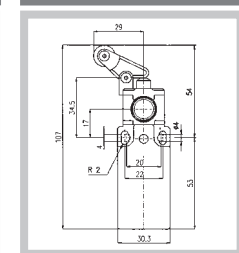
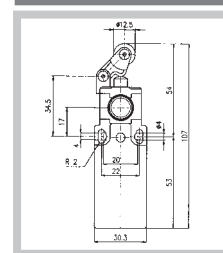
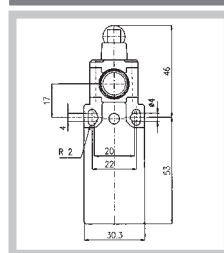
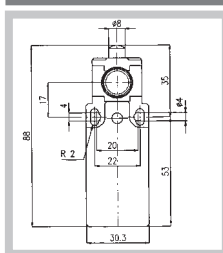
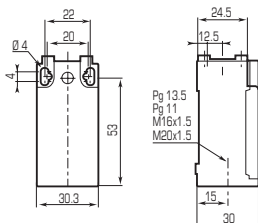

Safety Limit Switches

Safety Series - Limit Switches

IP65 □ thermoplastic type



AUTOMATION TECHNOLOGIES

1 cable entry
M16x1.5



ST1K1



ST1K61



ST1K71 Zinc Plated Steel Spindle
ST1K72 Stainless Steel Spindle



ST1K8

TYPE OF OPERATOR	90° ADJUSTABLE TURRET HEAD WITH ACTUATOR	ADJUSTABLE STEEL ROTARY LEVER	STEEL SPINDLE	360° ADJUSTABLE TURRET HEAD WITH ACTUATOR
Standard - Positive opening NC contacts (→)	- (→)	- (→)	- (→)	
Minimum tripping force N	-	-	-	-
Minimum positive opening force N	-	-	-	-
Z11 1NC-1NO 	ST1K1 * Z11	ST1K61Z11	Zinc Plated ST1K71Z11 Stainless ST1K72Z11	ST1K8 * Z11
X11 1NC-1NO 	ST1K1 * X11	ST1K61X11	Zinc Plated ST1K71X11 Stainless ST1K72X11	ST1K8 * X11
Y11 1NC-1NO overlapping 	ST1K1 * Y11	ST1K61Y11	Zinc Plated ST1K71Y11 Stainless ST1K72Y11	ST1K8 * Y11
Z02 2NC 	ST1K1 * Z02	ST1K61Z02	Zinc Plated ST1K71Z02 Stainless ST1K72Z02	ST1K8 * Z02
W02 2NC 	ST1K1 * W02	ST1K61W02	Zinc Plated ST1K71W02 Stainless ST1K72W02	ST1K8 * W02

WEIGHT gr - MIN. PACK QTY. 83 gr 1 pcs 96 gr 1 pcs 80 gr 1 pcs 90 gr 1 pcs

DIMENSIONS	83 gr	96 gr	80 gr	90 gr

* Include actuator type reference number i.e.: ST1K13Z11

Safety Limit Switches

Safety Series - Limit Switches

IP65 □ thermoplastic type

ACTUATORS

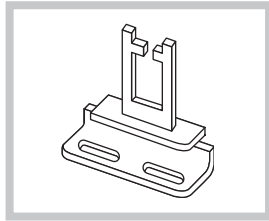

22MM RIGHT-ANGLED ACTUATOR

CODE

3

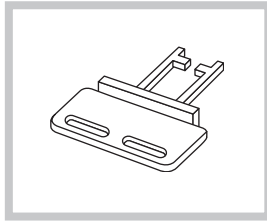

22MM STRAIGHT ACTUATOR

4

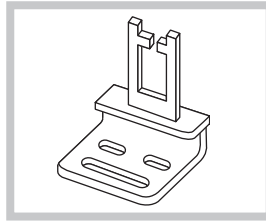

13MM RIGHT-ANGLED ACTUATOR

5

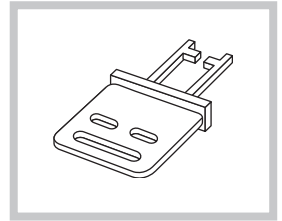

13MM STRAIGHT ACTUATOR

6

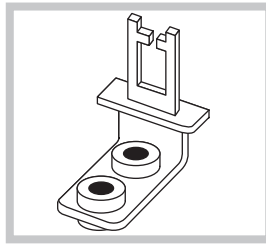

SHOCK ABSORBING RIGHT-ANGLED ACTUATOR

CODE

7

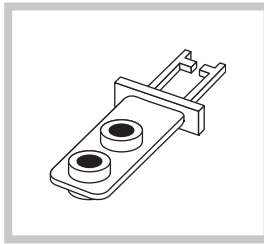

SHOCK ABSORBING STRAIGHT ACTUATOR

8

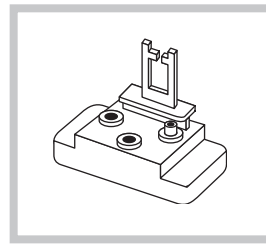

JOINTED KEY ACTUATOR

9

GENERAL CHARACTERISTICS

Safety limit switches are suitable for stopping dangerous machinery movements on opening of machine guards or protective covers. Available with different type of actuators and controls and with adjustable turret heads which can be rotated through 360° in 90° steps, they can be installed with a wide variety of opening mechanisms.

■ Comply with		IEC/EN60947-5-1, UL508		
■ Rated insulation voltage U_i	V	690		
■ Rated impulse withstand voltage U_{imp}	kV	6		
■ Operating frequency	Hz	50		
■ Rated thermal current I_{th}	A	10		
■ Rated operating current I_e :				
	V	24	230	380
AC15: alternate current	A	10	3.1	1.9
	V	24	250	-
DC13: direct current	A	2.8	0.27	-
■ Conditional short circuit withstand		10A gG fuse rating		
■ Electrical shocks withstand IEC 536		class II		
■ Protection rating IEC/EN 60529		IP65		
■ Operating temperature	°C	-25 +70		
■ Category of use UL 508		A600 - Q600		
■ Certifications		UL		

Limit Switches

FA - FT - FT1R Series

Installation and use



AUTOMATION TECHNOLOGIES

REVERSE MOUNTING OF THE OPERATING LEVER

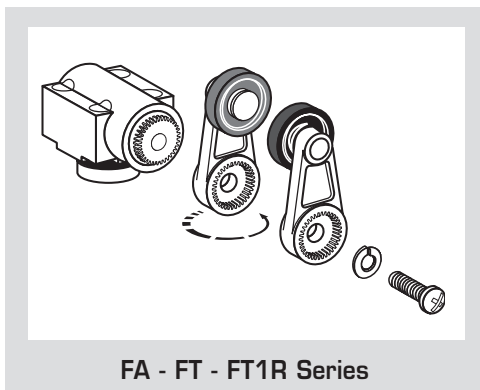

PLUNGER OR ROLLER LEVER

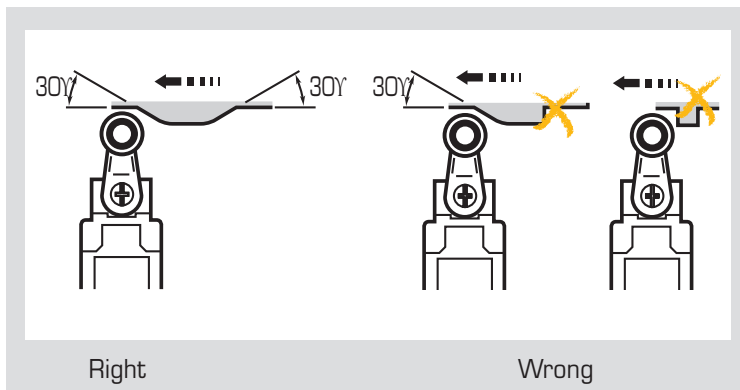

REST POSITION SETTING THROUGH 10° STEPS

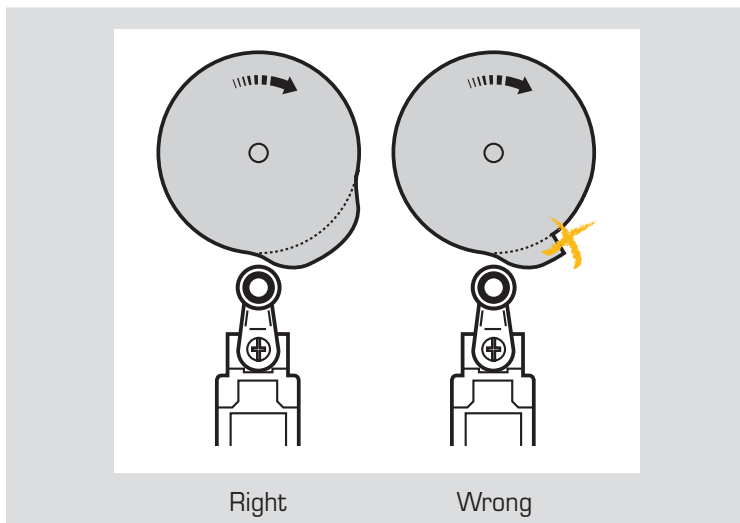
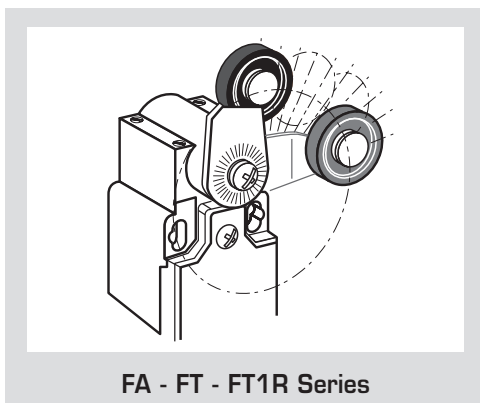

STEEL PLUNGER

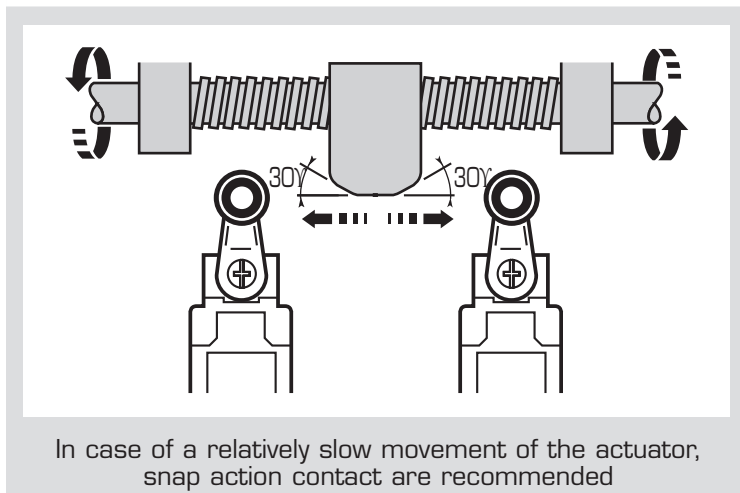
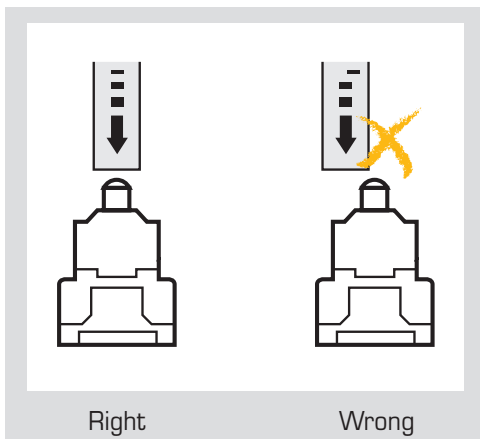

Limit Switches

FA - FT - FT1R Series

Technical data

GENERAL CHARACTERISTICS

Comply with	IEC947-5-1, EN60947-5-1, UL508, CSA 22.2 n° 14	
Certifications	cUL	
Ambient temperature	°C	Operating -25 +70
	°C	Storage -30 +80
Climate protection	IEC68 part 2-3	Hot damp
	IEC68 part 2-11	Saline fog
Installation positions	All positions	
Impact resistance	IEC68 part 2-27	50g* (1/2 sinusoidal shock for 11 msec) without replacing contacts
Vibration resistance	IEC68 part 2-6	25g (10...500 Hz) without replacing contacts >100 msec
Electrical shocks withstand	IEC536	Class II for FT series - Class I for FA series
Protection rating	EN60529	IP65 FT series - IP66 - FA series
Accuracy (measured after 1 million operations)	0.05 FA series - 0.1 FT series (on the making point)	
0.05 Minimum tripping force	m/s	Slow break 0.06 - snap action 0.001
Rated insulation voltage Ui (IEC/EN60947-1)	V	690 FT series - 400 FA series
according to UL508 and CSA C22-2 No. 14	V	(3 pollution grade)
Rated impulse withstand voltage Uimp (IEC/EN60947-1)	kV	600 (designation A600 - Q600)
Rated thermal current Ith (IEC/EN60947-1)	A	6
Short circuit protection <500 Va.c. - fuses type gG (gl7)	A	10
Rated operating current Ie:		
AC-15 (IEC/EN60947-5-1)	24 V - 50/60 Hz A	10
	120 V - 50/60 Hz A	6
	230 V - 50/60 Hz A	3.1
	240 V - 50/60 Hz A	3
	400 V - 50/60 Hz A	1.9
DC-13 (IEC/EN60947-5-1)	24 V - 50/60 Hz A	2.8
	125 V - 50/60 Hz A	0.55
	250 V - 50/60 Hz A	0.27
Changeover frequency	cycles/hour	3600
Load factor		0.5
Contact insulation resistance	m Ω	25
Termination type	M3.5 screw clamp terminals (+/-) pozidriv 2	
Earth terminal (FA series only)	M3.5 screw clamp terminals (+/-) pozidriv 2	
Terminal capacity solid/flexible conductor	n.1 o 2 x mm ²	0.75...2.5
Terminal referencing	according to EN50013	
Mechanical life	milions of operations	15 FA. 31; 32; 33
		10 FT. 34; 37; 38...41
		>5 FT. P31...P33; 35; 36
Electrical life (according to IEC/EN60947-5-1)	AC-15 and DC-13 categories of use (0.5 load factor according to the diagrams below)	

**AC-15
Snap
action**

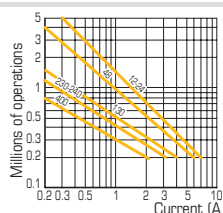

**AC-15
Slow
break**

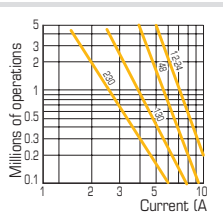

* 25gr for FA.40 and FT.40

DC-13 Snap action Slow break

Breaking capacity for a duration of 5 millions cycles

Voltage 24 V	9.5 W	12 W
Voltage 48 V	6.8 W	9 W
Voltage 110 V	3.6 W	6 W

Limit Switches

Pre-wired FCT series

IP67 □ thermoplastic type



AUTOMATION TECHNOLOGIES

Cable: PVC UL
5x0.75 mm²
2 m length
Outlet: horizontal .L.
vertical .V.



.01.



.02.



.03.



.04.

TYPE OF OPERATOR	CABLE OUTLET	STEEL END PLUNGER	ROLLER PLUNGER	90° ROLLER PLUNGER	ROLLER LEVER Ø 14
X11 1NC-1NO 		FCT2L01X11	FCT2L02X11	FCT2L03X11	FCT2L04X11
		FCT2V01X11	FCT2V02X11	FCT2V03X11	FCT2V04X11
WEIGHT gr. - MIN. PACK QTY.		75 gr 1 pz	78 gr 1 pz	80 gr 1 pz	80 gr 1 pz
DIMENSIONS					

Cable: PVC UL
5x0.75 mm²
2 m length
Outlet: horizontal .L.
vertical .V.



.06.



.07.



.08.

TYPE OF OPERATOR	CABLE OUTLET	STEEL END PLUNGER WITH THREADED FLANGE	ROLLER PLUNGER WITH THREADED FLANGE	90° ROLLER PLUNGER WITH THREADED FLANGE	CHARACTERISTICS
X11 1NC-1NO 		FCT2L06X11	FCT2L07X11	FCT2L08X11	IEC/EN60947-5-1 Rated insulation voltage U _i /500V Rated thermal current I _{th} 10A Rated operating current I _e : AC15 U _e V 120 250 400 I _e A 6 4 3 DC13 U _e V 24 125 250 I _e A 2,5 0,55 0,27 UL508 General use Designation A300-Q300 Operating temperature -25 +70 °C Self extinguishing body VO
		FCT2V06X11	FCT2V07X11	FCT2V08X11	
WEIGHT gr - MIN. PACK QTY.		75 gr 1 pz	78 gr 1 pz	80 gr 1 pz	
DIMENSIONS					

Limit Switches

Pre-wired FCM series

IP67 Metal type



Cable: PVC UL
5x0.75 mm²
2 m length
Outlet: horizontal .L.



.01.



.02.



.03.



.04.

TYPE OF OPERATOR	STEEL END PLUNGER	ROLLER PLUNGER	90° ROLLER PLUNGER	14 Ø POM ROLLER LEVER
------------------	-------------------	----------------	--------------------	-----------------------

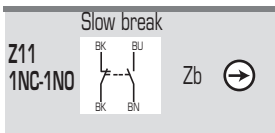

WEIGHT gr - MIN. PACK QTY.

DIMENSIONS

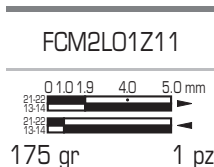
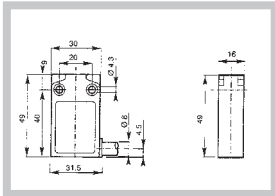

175 gr 1 pz

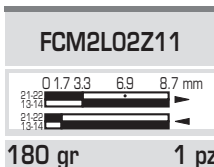
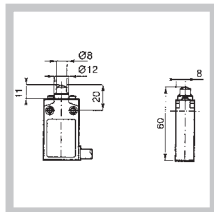

180 gr 1 pz

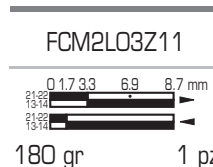
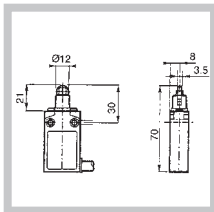

180 gr 1 pz

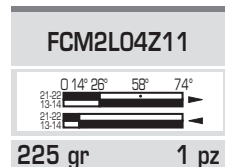
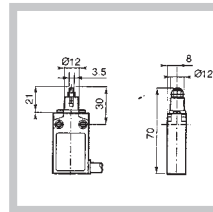

225 gr 1 pz

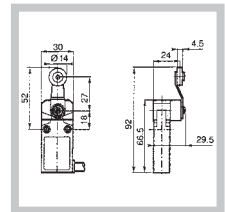

Cable: PVC UL
5x0.75 mm²
2 m length
Outlet: horizontal .L.



.06.



.07.



.08.

TYPE OF OPERATOR	STEEL END PLUNGER WITH THREADED FLANGE	ROLLER PLUNGER WITH THREADED FLANGE	90° ROLLER PLUNGER WITH THREADED FLANGE	CHARACTERISTICS
------------------	--	-------------------------------------	---	-----------------

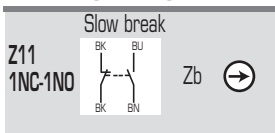

WEIGHT gr - MIN. PACK QTY.

DIMENSIONS

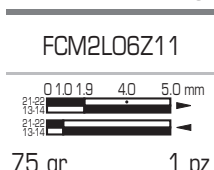
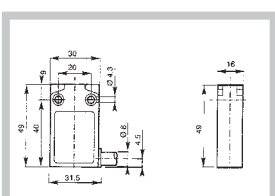

75 gr 1 pz

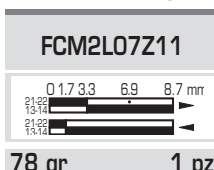
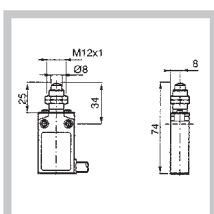

78 gr 1 pz

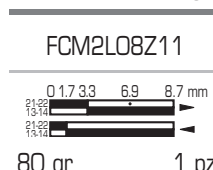
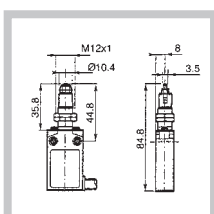

80 gr 1 pz

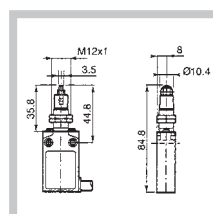

IEC/EN60947-5-1
Rated insulation voltage
U_i/500V
Rated thermal current I_{th} 5A
Rated operating current I_e:

AC15	U _e V	24	120	240
	I _e A	5	3	1,5
DC13	U _e V	24	125	250
	I _e A	1	0,22	0,1

Pollution class | 3
Material group | I
Operating temperatures | -25 +70 °C

Limit Switches

Astra Series

IP54 universal type



AUTOMATION TECHNOLOGIES

2 cable entries
with cable gland



TYPE OF OPERATOR	STEEL ROLLER PLUNGER	ROLLER LEVER Ø 20	ROLLER LEVER Ø 35	ROLLER PLUNGER AND LEVER WITH RESET
1NC-1NO Slow break 	30303061 	30303073 	30303025 	30303092 lever
1NC-1NO overlapping Slow break 	30303062 	30303074 	30303026 	30303098 with plunger
WEIGHT gr - MIN. PACK QTY.	130 gr 1 pz	160 gr 1 pz	200 gr 1 pz	180 gr 1 pz
DIMENSIONS				

GENERAL CHARACTERISTICS

Comply with	IEC/EN60947-5-1						
Rated insulation voltage U_i	500 (pollution class 3)						
Rated impulse withstand voltage U_{imp}	4						
Operating frequency	50/60						
Rated thermal current I_{th}	10						
Rated operating current I_e : AC-15 alterante current	<table border="1"> <tr> <td>110</td> <td>230</td> <td>380</td> </tr> <tr> <td>8</td> <td>8</td> <td>6</td> </tr> </table>	110	230	380	8	8	6
110	230	380					
8	8	6					
Contact type	Slow break double gap contacts						
Protection rating	IP54						
Ambient temperature	Operating -25 +55 Storage -30 +70						
Termination type	Screw clamp terminals						
Materials	Housing in reinforced PA - PC lid Nickel brass plunger - Reinforced PC lever						

Micro Switches

MFI Series

Table of contents

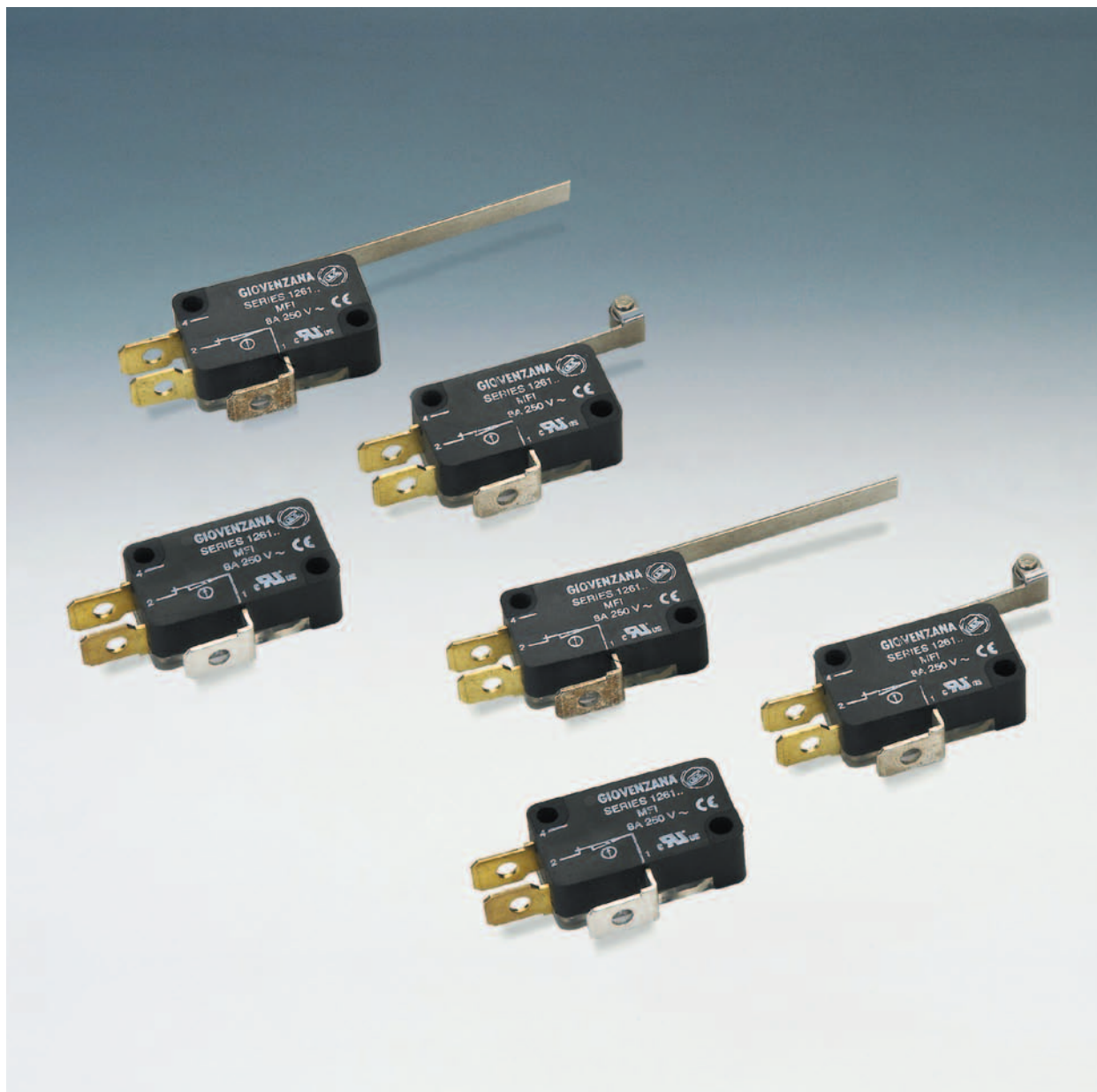

Standard micro switches with self cleaning contacts
Supplied with operator.

TABLE OF CONTENTS

- MFI Series

pag.125

Micro Switches

MFI Series

DIN 41635A - 6.3x0.8 connectors



AUTOMATION TECHNOLOGIES



- Changeover contacts
- High reliability snap action contacts
- Silver alloy self cleaning contacts
- Positive opening NC contact \odot
- 7 versions available
- Certifications:

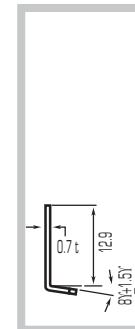
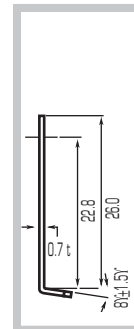
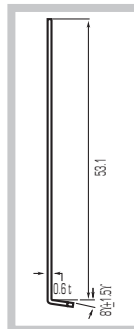
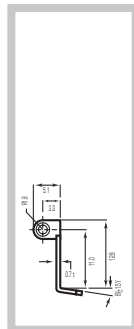
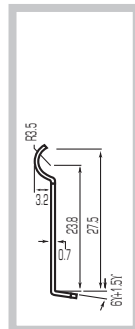
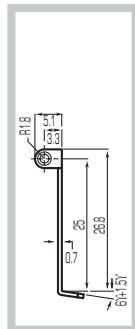
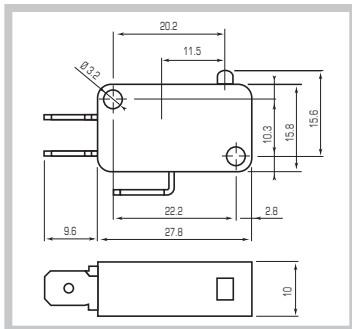

PIN PLUNGER

LONG ROLLER LEVER

SIMULATED ROLLER LEVER

ROLLER LEVER

LONG LEVER

LEVER

SHORT LEVER

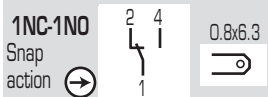

MFI

MFI.1

MFI.2

MFI.3

MFI.4

MFI.5

MFI.6

Operating force	N	4,5	3,2	3,2	4,5	1,3	3,2	4,5
Resetting force	N	1,9	1,2	1,2	1,9	0,15	1,2	1,9
Max pre travel PT	mm	1,4	3,3	3,3	1,4	7,6	3,3	1,4
Min over travel	mm	0,8	0,8	0,8	0,6	2,2	0,8	0,6
Tripping position OP	mm	14,4±0,4	21,8±1,2	18,9±1,2	20±0,6	15,2±1,2	15,2±1,2	15,1±0,5

GENERAL CHARACTERISTICS

■ Comply with	IEC/EN61058, UL1054
■ Rated insulation voltage U_i	250V
■ Rated impulse withstand voltage U_{imp}	1500
■ Rated thermal current I_{th}	8
■ Rated operating current I_e :	8A - 250V resistive load, 3A - 250V inductive load
■ Ambient temperature	-25 +85
■ Electric shock protection	Class II
■ Pollution class	2
■ Life	Mechanical 10^6 , electrical 5×10^5
■ Termination type	6.3x0.8 faston terminal

Foot switches

IP Series

Table of contents



Single or double foot switches with the EN ISO 13850 emergency stop option.
Available with electric or pneumatic controls.

TABLE OF CONTENTS

■ Single foot switches	pag. 127	■ Double foot switches – Technical data	pag. 128
------------------------	----------	---	----------

Foot switches

IP Series

IP54 □ thermoplastic type - Single



AUTOMATION TECHNOLOGIES

SAFETY FOOT SWITCHES

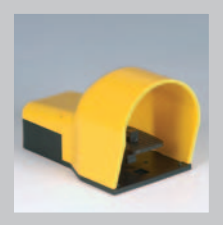
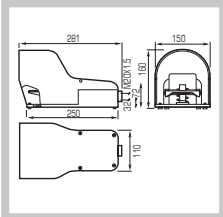
DESCRIPTION	CONTACTS	CODE	WEIGHT gr	MIN. PACK QTY.	DIMENSIONS
 <p>With trigger mechanism requiring positive action to allow pedal operation</p>	Slow break *	IP7007	1.400	1	
	1NO				

FOOT SWITCHES

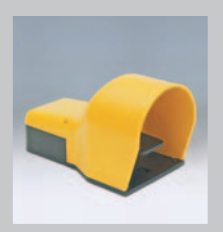
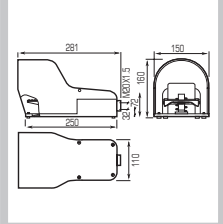
DESCRIPTION	CONTACTS	CODE	WEIGHT gr	MIN. PACK QTY.	DIMENSIONS
 <p>With pedal latching device and without trigger mechanism</p>	Slow break *	IP 7011	1.400	1	
	1NO				

 <p>Without rest position trigger mechanism</p>	Slow break *	1NC+1NO	IP7006I	1.300	1	
	1NC+1NO					

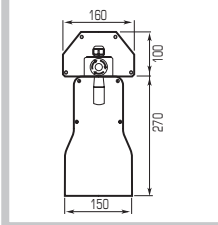
 <p>With trigger mechanism and EN ISO 13850 emergency stop</p>	Slow break *	IP7007EM	3.900	1	
	Slow break * Two speeds	2NO	IP7015EM		

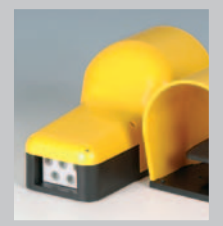
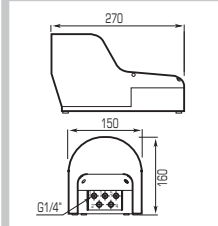
 <p>Pneumatic with trigger mechanism</p>	With 1/4" 5 ways valve	IP7023	1.600	1	
		IP7024		1	

(*) On request can be supplied with snap action contacts

Foot switches

IP Series

IP54 □ thermoplastic type - Double

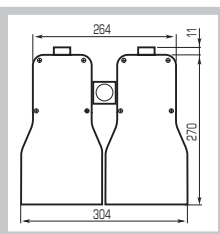
DOUBLE						
DESCRIPTION	CONTACTS	CODE	WEIGHT gr	MIN. PACK QTY.	DIMENSIONS	
 <p>With trigger mechanism requiring positive action to allow pedal operation</p>	Slow break *		3.100	1		
	1NO	IP7018				
	2NO	IP7019				

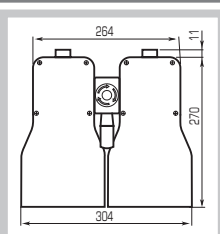
DOUBLE WITH EN418 EMERGENCY STOP						
DESCRIPTION	CONTACTS	CODE	WEIGHT gr	MIN. PACK QTY.	DIMENSIONS	
 <p>With trigger mechanism requiring positive action to allow pedal operation</p>	Slow break *		5.300	1		
	1NO	IP7018EM				
	2NO	IP7019EM				

(*) On request can be supplied with snap action contacts

GENERAL CHARACTERISTICS

Comply with		IEC/EN60947-5-1										
Rated insulation voltage U_i	V	690 (pollution class 3)										
Rated impulse withstand voltage U_{imp}	kV	4										
Operating frequency	Hz	50/60										
Rated thermal current I_{th}	A	10										
Rated operating current I_e :												
AC-15 alterante current	V	<table border="1"> <tr> <td>24</td><td>60</td><td>110</td><td>230</td><td>400</td> </tr> <tr> <td>16</td><td>12</td><td>8</td><td>6</td><td>4,5</td> </tr> </table>	24	60	110	230	400	16	12	8	6	4,5
24	60	110	230	400								
16	12	8	6	4,5								
DC-13 continuous current	A	<table border="1"> <tr> <td>24</td><td>48</td><td>60</td><td>110</td><td>230</td> </tr> <tr> <td>2</td><td>1,2</td><td>0,85</td><td>0,4</td><td>0,25</td> </tr> </table>	24	48	60	110	230	2	1,2	0,85	0,4	0,25
24	48	60	110	230								
2	1,2	0,85	0,4	0,25								
Conditional short circuit withstand		1000A - 10A-500V class gG fuses										
Contact impedance	mΩ	≤25										
Contact type		Slow break double gap contacts										
Positive opening		NC contact with positive opening 										
Electric shock protection	IEC 536	Class II										
Protection rating	IEC 529	IP54										
Ambient temperature	°C	Operating -25 +70										
Termination type	°C	Storage -30 +70										
Cable entry		Screw clamp terminals										
		No. 1 M20x1.5										

(*) On request can be supplied with snap action contacts



GIOVENZANA INTERNATIONAL B.V.

1077 XX Amsterdam, The Netherlands
WTC Strawinskylaan 1105
Ph. +31(0) 20.4413576 - Fax +31(0) 20.4413456
e-mail:giovenzana@giovenzana.com

G.M.K. K.f.t.

1068 Budapest, Hungary
Rippl Ronai ut.13
Ph. +36.37.572575 - Fax +36.37.572570
e-mail: gmk@giovenzana.com

G.T.R. LCC

Moscow, Russian Federation
Ulitsa Radio 24, Yauza Tower 4th floor
Ph. +7.495.6991296 / 6503959 - Fax +7.495.6991520
e-mail:gtr@giovenzana.com

GIOVENZANA CONTROLS Pvt. Ltd.

Malad (West) Mumbai, Maharashtra 400064, India
203, A-Wing Knox Plaza, Off Link Road Mindspace
Ph. +91.22.42640071
e-mail: ggindia@giovenzana.com

Branch

DUBAI U.A.E. P.O. Box 262146 - J.A.F.Z.A. 15, Jebel Ali Free Zone
Ph. +971.4.8870788 - Fax +971.4.8870787
e-mail: uae@giovenzana.com